

TEST REPORT

Application No.: GZEM2004011519HS
Applicant: Baren Home Appliance Technology (Dongguan) Co., Ltd.
Address of Applicant: No. 151, Niuguo Road, Qiufulu Village, Dalang Town, Dongguan, Guangdong, China
Manufacturer: The same as applicant
Address of Manufacturer: The same as applicant
Factory: The same as applicant
Address of Factory: The same as applicant
Equipment Under Test (EUT):
EUT Name: Air purifier
Model No.: B-C02
Trade Mark: BAREN
Standard(s): EN 55014-1:2017
 EN 55014-2:2015
 EN IEC 61000-3-2:2019
 EN 61000-3-3:2013 +A1:2019
Date of Receipt: 2020-04-11
Date of Test: 2020-04-24 to 2020-05-13
Date of Issue: 2020-06-17

Test Result:	Pass*
---------------------	--------------

* In the configuration tested, the EUT complied with the standards specified above.

The CE mark as shown below can be used, under the responsibility of the manufacturer, after completion of an EU Declaration of Conformity and compliance with all relevant EU Directives.

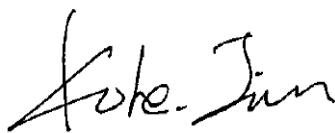



Kobe Jian
EMC Laboratory Manager



Unless otherwise agreed in writing, this document is issued by the Company subject to its General Conditions of Service printed overleaf, available on request or accessible at <http://www.sgs.com/en/Terms-and-Conditions.aspx> and, for electronic format documents, subject to Terms and Conditions for Electronic Documents at <http://www.sgs.com/en/Terms-and-Conditions/Terms-e-Documents.aspx>. Attention is drawn to the limitation of liability, indemnification and jurisdiction issues defined therein. Any holder of this document is advised that information contained hereon reflects the Company's findings at the time of its intervention only and within the limits of Client's instructions, if any. The Company's sole responsibility is to its Client and this document does not exonerate parties to a transaction from exercising all their rights and obligations under the transaction documents. This document cannot be reproduced except in full, without prior written approval of the Company. Any unauthorized alteration, forgery or falsification of the content or appearance of this document is unlawful and offenders may be prosecuted to the fullest extent of the law. Unless otherwise stated the results shown in this test report refer only to the sample(s) tested and such sample(s) are retained for 30 days only.
Attention: To check the authenticity of testing /inspection report & certificate, please contact us at telephone: (86-755) 8307 1443, or email: CN.Doccheck@sgs.com

Revision Record				
Version	Chapter	Date	Modifier	Remark
01		2020-06-17		Original

Authorized for issue by:			
Tested By			
	Allen_Zhou /Project Engineer		2020-04-24 to 2020-05-13 Date
Checked By			
	Terry_Lai /Reviewer		2020-06-17 Date



Unless otherwise agreed in writing, this document is issued by the Company subject to its General Conditions of Service printed overleaf, available on request or accessible at <http://www.sgs.com/en/Terms-and-Conditions.aspx> and, for electronic format documents, subject to Terms and Conditions for Electronic Documents at <http://www.sgs.com/en/Terms-and-Conditions/Terms-e-Documents.aspx>. Attention is drawn to the limitation of liability, indemnification and jurisdiction issues defined therein. Any holder of this document is advised that information contained hereon reflects the Company's findings at the time of its intervention only and within the limits of Client's instructions, if any. The Company's sole responsibility is to its Client and this document does not exonerate parties to a transaction from exercising all their rights and obligations under the transaction documents. This document cannot be reproduced except in full, without prior written approval of the Company. Any unauthorized alteration, forgery or falsification of the content or appearance of this document is unlawful and offenders may be prosecuted to the fullest extent of the law. Unless otherwise stated the results shown in this test report refer only to the sample(s) tested and such sample(s) are retained for 30 days only.

Attention: To check the authenticity of testing /inspection report & certificate, please contact us at telephone: (86-755) 8307 1443, or email: CN.Doccheck@sgs.com

2 Test Summary

Emission Part				
Item	Standard	Method	Requirement	Result
Conducted Emissions at Mains Terminals (150kHz-30MHz)	EN 55014-1:2017	CISPR 16-2-1	N/A	Pass
Disturbance Power	EN 55014-1:2017	CISPR 16-2-2	N/A	Pass
Harmonic Current Emission	EN IEC 61000-3-2:2019	EN IEC 61000-3-2:2019	Class A	Pass
Voltage Fluctuations and Flicker	EN 61000-3-3:2013 +A1:2019	EN 61000-3-3:2013 +A1:2019	Clause 5 of EN 61000-3-3	Pass

N/A: Not applicable

Immunity Part				
Item	Standard	Method	Requirement	Result
Electrostatic Discharge	EN 55014-2:2015	EN 61000-4-2:2009	4kV Contact Discharge 8kV Air Discharge	Pass
Radiated Immunity (80MHz-1GHz)	EN 55014-2:2015	EN 61000-4-3:2006 +A1:2008+A2:2010	3V/m, 80%, 1kHz Amp. Mod.	Pass
Electrical Fast Transients/Burst at Power Port	EN 55014-2:2015	EN 61000-4-4:2012	1kV 5/50ns Tr/Td 5kHz Repetition Frequency	Pass
Surge at Power Port	EN 55014-2:2015	EN 61000-4-5:2014	1.2/50µs Tr/Td 1kV Line to Line	Pass
Voltage Dips and Interruptions	EN 55014-2:2015	EN 61000-4-11:2004	For 50Hz: 0 % UT for 0.5cycle 40 % UT for 10cycles 70 % UT for 25cycles UT is Supply Voltage	Pass
Conducted Immunity at Power Port (150kHz-230MHz)	EN 55014-2:2015	EN 61000-4-6:2014	3Vrms (emf),80%,1kHz Amp. Mod.	Pass

N/A: Not applicable



Unless otherwise agreed in writing, this document is issued by the Company subject to its General Conditions of Service printed overleaf, available on request or accessible at <http://www.sgs.com/en/Terms-and-Conditions.aspx> and, for electronic format documents, subject to Terms and Conditions for Electronic Documents at <http://www.sgs.com/en/Terms-and-Conditions/Terms-e-Documents.aspx>. Attention is drawn to the limitation of liability, indemnification and jurisdiction issues defined therein. Any holder of this document is advised that information contained hereon reflects the Company's findings at the time of its intervention only and within the limits of Client's instructions, if any. The Company's sole responsibility is to its Client and this document does not exonerate parties to a transaction from exercising all their rights and obligations under the transaction documents. This document cannot be reproduced except in full, without prior written approval of the Company. Any unauthorized alteration, forgery or falsification of the content or appearance of this document is unlawful and offenders may be prosecuted to the fullest extent of the law. Unless otherwise stated the results shown in this test report refer only to the sample(s) tested and such sample(s) are retained for 30 days only.
Attention: To check the authenticity of testing /inspection report & certificate, please contact us at telephone: (86-755) 8307 1443, or email: CN.Doccheck@sgs.com

3 Contents

	Page
1 Cover Page.....	1
2 Test Summary.....	3
3 Contents	4
4 General Information.....	6
4.1 Details of E.U.T.	6
4.2 Description of Support Units	6
4.3 Measurement Uncertainty	6
4.4 Test Location.....	6
4.5 Test Facility	7
4.6 Deviation from Standards.....	8
4.7 Abnormalities from Standard Conditions.....	8
5 Equipment List.....	9
6 Emission Test Results	12
6.1 Conducted Emissions at Mains Terminals (150kHz-30MHz).....	12
6.1.1 E.U.T. Operation.....	12
6.1.2 Test Setup Diagram.....	12
6.1.3 Measurement Data	12
6.2 Disturbance Power.....	15
6.2.1 E.U.T. Operation.....	15
6.2.2 Test Setup Diagram.....	15
6.2.3 Measurement Data	15
6.3 Harmonic Current Emission	17
6.3.1 E.U.T. Operation.....	17
6.3.2 Test Setup Diagram.....	17
6.3.3 Measurement Data	18
6.4 Voltage Fluctuations and Flicker	20
6.4.1 E.U.T. Operation.....	20
6.4.2 Test Setup Diagram.....	20
6.4.3 Measurement Data	21
7 Immunity Test Results	22
7.1 Performance Criteria Description in EN 55014-2:2015	22
7.2 Electrostatic Discharge	23
7.2.1 E.U.T. Operation.....	23
7.2.2 Test Setup Diagram.....	23
7.2.3 Test Results	24
7.3 Radiated Immunity (80MHz-1GHz).....	25
7.3.1 E.U.T. Operation.....	25
7.3.2 Test Setup Diagram.....	25
7.3.3 Test Results	26
7.4 Electrical Fast Transients/Burst at Power Port.....	27
7.4.1 E.U.T. Operation.....	27



Unless otherwise agreed in writing, this document is issued by the Company subject to its General Conditions of Service printed overleaf, available on request or accessible at <http://www.sgs.com/en/Terms-and-Conditions.aspx> and, for electronic format documents, subject to Terms and Conditions for Electronic Documents at <http://www.sgs.com/en/Terms-and-Conditions/Terms-e-Document.aspx>. Attention is drawn to the limitation of liability, indemnification and jurisdiction issues defined therein. Any holder of this document is advised that information contained hereon reflects the Company's findings at the time of its intervention only and within the limits of Client's instructions, if any. The Company's sole responsibility is to its Client and this document does not exonerate parties to a transaction from exercising all their rights and obligations under the transaction documents. This document cannot be reproduced except in full, without prior written approval of the Company. Any unauthorized alteration, forgery or falsification of the content or appearance of this document is unlawful and offenders may be prosecuted to the fullest extent of the law. Unless otherwise stated the results shown in this test report refer only to the sample(s) tested and such sample(s) are retained for 30 days only.

Attention: To check the authenticity of testing /inspection report & certificate, please contact us at telephone: (86-755) 8307 1443, or email: CN.Doccheck@sgs.com

7.4.2	Test Setup Diagram	27
7.4.3	Test Results	27
7.5	Surge at Power Port	28
7.5.1	E.U.T. Operation	28
7.5.2	Test Setup Diagram	28
7.5.3	Test Results	28
7.6	Voltage Dips and Interruptions	29
7.6.1	E.U.T. Operation	29
7.6.2	Test Setup Diagram	29
7.6.3	Test Results	30
7.7	Conducted Immunity at Power Port (150kHz-230MHz)	31
7.7.1	E.U.T. Operation	31
7.7.2	Test Setup Diagram	31
7.7.3	Test Results	31
8	Photographs	32
8.1	Conducted Emissions at Mains Terminals (150kHz-30MHz) Test Setup	32
8.2	Disturbance Power Test Setup	33
8.3	Harmonic current emission, Voltage Fluctuations and Flicker Test Setup	34
8.4	Electrostatic Discharge Test Setup	35
8.5	Radiated Immunity (80MHz-1GHz) Test Setup	35
8.6	Electrical Fast Transients/Burst at Power Port Test Setup	36
8.7	Surge at Power Port Test Setup	37
8.8	Voltage Dips and Interruptions Test Setup	38
8.9	Conducted Immunity at Power Port (150kHz-230MHz) Test Setup	39
8.10	EUT Constructional Details	40



Unless otherwise agreed in writing, this document is issued by the Company subject to its General Conditions of Service printed overleaf, available on request or accessible at <http://www.sgs.com/en/Terms-and-Conditions.aspx> and, for electronic format documents, subject to Terms and Conditions for Electronic Documents at <http://www.sgs.com/en/Terms-and-Conditions/Terms-e-Document.aspx>. Attention is drawn to the limitation of liability, indemnification and jurisdiction issues defined therein. Any holder of this document is advised that information contained hereon reflects the Company's findings at the time of its intervention only and within the limits of Client's instructions, if any. The Company's sole responsibility is to its Client and this document does not exonerate parties to a transaction from exercising all their rights and obligations under the transaction documents. This document cannot be reproduced except in full, without prior written approval of the Company. Any unauthorized alteration, forgery or falsification of the content or appearance of this document is unlawful and offenders may be prosecuted to the fullest extent of the law. Unless otherwise stated the results shown in this test report refer only to the sample(s) tested and such sample(s) are retained for 30 days only.
Attention: To check the authenticity of testing /inspection report & certificate, please contact us at telephone: (86-755) 8307 1443, or email: CN.Doccheck@sgs.com

4 General Information

4.1 Details of E.U.T.

Power Supply:	AC 220-240V 50Hz DC 3V= 2 x DC 1.5V "AAA" batteries for remote controller
Test voltage:	AC 230V 50Hz
Rated power:	80W
Cable:	2 wires x 1.0m unscreened AC mains cable

4.2 Description of Support Units

The EUT has been tested as an independent unit.

4.3 Measurement Uncertainty

No.	Item	Measurement Uncertainty
1	Conducted Disturbance Voltage at Mains Terminals	±3.63dB (9kHz to 150kHz)
		±3.22dB (150kHz to 30MHz)
2	Disturbance Power	±3.78dB
3	Radiated Emissions	±5.0dB (30MHz-1GHz)
		±5.0dB (1GHz-6GHz)
4	Radiated Immunity	±2.18dB(80MHz-3GHz)
5	Conducted Immunity	±3.5dB(150kHz-230MHz)
6	Electrostatic Discharge	±6 %
7	EFT (Electrical Fast Transients)	±4 %
8	Surge Immunity	±6%
9	Voltage Dips and Interruptions	±4 %
10	CISPR 20 Immunity	±1.5dB
11	Temperature	±0.4°C
12	Humidity	±1.3%
13	DC power	±0.5 %

4.4 Test Location

All tests were performed at:

SGS-CSTC Standards Technical Services Co., Ltd., Guangzhou Branch EMC Laboratory,
 198 Kezhu Road, Sciencetech Park, Guangzhou Economic & Technology Development District,
 Guangzhou, China 510663

Tel: +86 20 82155555 Fax: +86 20 82075059

No tests were sub-contracted.



Unless otherwise agreed in writing, this document is issued by the Company subject to its General Conditions of Service printed overleaf, available on request or accessible at <http://www.sgs.com/en/Terms-and-Conditions.aspx> and, for electronic format documents, subject to Terms and Conditions for Electronic Documents at <http://www.sgs.com/en/Terms-and-Conditions/Terms-e-Documents.aspx>. Attention is drawn to the limitation of liability, indemnification and jurisdiction issues defined therein. Any holder of this document is advised that information contained hereon reflects the Company's findings at the time of its intervention only and within the limits of Client's instructions, if any. The Company's sole responsibility is to its Client and this document does not exonerate parties to a transaction from exercising all their rights and obligations under the transaction documents. This document cannot be reproduced except in full, without prior written approval of the Company. Any unauthorized alteration, forgery or falsification of the content or appearance of this document is unlawful and offenders may be prosecuted to the fullest extent of the law. Unless otherwise stated the results shown in this test report refer only to the sample(s) tested and such sample(s) are retained for 30 days only.

Attention: To check the authenticity of testing /inspection report & certificate, please contact us at telephone: (86-755) 8307 1443, or email: CN.Doccheck@sgs.com

4.5 Test Facility

The test facility is recognized, certified, or accredited by the following organizations:

● **NVLAP (Lab Code: 200611-0)**

SGS-CSTC Standards Technical Services Co., Ltd., Guangzhou EMC Laboratory is accredited by the National Voluntary Laboratory Accreditation Program (NVLAP/NIST). NVLAP Code: 200611-0.

The report must not be used by the client to claim product certification, approval, or endorsement by NVLAP, NIST, or any agency of the Federal Government.

● **ACMA**

SGS-CSTC Standards Technical Services Co., Ltd., EMC Laboratory can also perform testing for the Australian C-Tick mark as a result of our NVLAP accreditation.

● **SGS UK(Certificate No.: 32), SGS-TUV SAARLAND and SGS-FIMKO**

Have approved SGS-CSTC Standards Technical Services Co., Ltd., EMC Laboratory as a supplier of EMC TESTING SERVICES and SAFETY TESTING SERVICES.

● **CNAS (Lab Code: L0167)**

SGS-CSTC Standards Technical Services Co., Ltd., EMC Laboratory has been assessed and in compliance with CNAS-CL01:2018 accreditation criteria for testing laboratories (identical to ISO/IEC 17025:2017 General Requirements) for the Competence of Testing Laboratories.

● **FCC Recognized 2.948 Listed Test Firm(Registration No.: 282399)**

SGS-CSTC Standards Technical Services Co., Ltd., EMC Laboratory has been registered and fully described in a report filed with the (FCC) Federal Communications Commission. The acceptance letter from the FCC is maintained in our files. Registration 282399, May 31, 2002.

● **FCC Recognized Accredited Test Firm(Registration No.: 486818)**

SGS-CSTC Standards Technical Services Co., Ltd., EMC Laboratory has been accredited and fully described in a report filed with the (FCC) Federal Communications Commission. The acceptance letter from the FCC is maintained in our files. Designation Number: CN5016, Test Firm Registration Number: 486818, Jul 13, 2017.

● **Industry Canada (Registration No.: 4620B, CAB identifier: CN0052)**

SGS-CSTC Standards Technical Services Co., Ltd., has been registered by Innovation Science and Economic Development Canada for Wireless Device Testing laboratories to test to Canadian radio equipment requirements. Registration No. 4620B, CAB identifier: CN0052.

● **VCCI (Registration No.: R-12460, C-12584, G-10449 and T-11179)**

The 10m Semi-anechoic chamber and Shielded Room of SGS-CSTC Standards Technical Services Co., Ltd. have been registered in accordance with the Regulations for Voluntary Control Measures with Registration No.: R-12460, C-12584, G-10449 and T-11179 respectively.

● **CBTL (Lab Code: TL129)**

SGS-CSTC Standards Technical Services Co., Ltd., E&E Laboratory has been assessed and fully comply with the requirements of ISO/IEC 17025:2005, the Basic Rules, IECEE 01 and Rules of procedure IECEE 02, and the relevant IECEE CB-Scheme Operational documents.



Unless otherwise agreed in writing, this document is issued by the Company subject to its General Conditions of Service printed overleaf, available on request or accessible at <http://www.sgs.com/en/Terms-and-Conditions.aspx> and, for electronic format documents, subject to Terms and Conditions for Electronic Documents at <http://www.sgs.com/en/Terms-and-Conditions/Terms-e-Documents.aspx>. Attention is drawn to the limitation of liability, indemnification and jurisdiction issues defined therein. Any holder of this document is advised that information contained hereon reflects the Company's findings at the time of its intervention only and within the limits of Client's instructions, if any. The Company's sole responsibility is to its Client and this document does not exonerate parties to a transaction from exercising all their rights and obligations under the transaction documents. This document cannot be reproduced except in full, without prior written approval of the Company. Any unauthorized alteration, forgery or falsification of the content or appearance of this document is unlawful and offenders may be prosecuted to the fullest extent of the law. Unless otherwise stated the results shown in this test report refer only to the sample(s) tested and such sample(s) are retained for 30 days only.
Attention: To check the authenticity of testing /inspection report & certificate, please contact us at telephone: (86-755) 8307 1443, or email: CN.Doccheck@sgs.com

4.6 Deviation from Standards

None

4.7 Abnormalities from Standard Conditions

None



Unless otherwise agreed in writing, this document is issued by the Company subject to its General Conditions of Service printed overleaf, available on request or accessible at <http://www.sgs.com/en/Terms-and-Conditions.aspx> and, for electronic format documents, subject to Terms and Conditions for Electronic Documents at <http://www.sgs.com/en/Terms-and-Conditions/Terms-e-Documents.aspx>. Attention is drawn to the limitation of liability, indemnification and jurisdiction issues defined therein. Any holder of this document is advised that information contained hereon reflects the Company's findings at the time of its intervention only and within the limits of Client's instructions, if any. The Company's sole responsibility is to its Client and this document does not exonerate parties to a transaction from exercising all their rights and obligations under the transaction documents. This document cannot be reproduced except in full, without prior written approval of the Company. Any unauthorized alteration, forgery or falsification of the content or appearance of this document is unlawful and offenders may be prosecuted to the fullest extent of the law. Unless otherwise stated the results shown in this test report refer only to the sample(s) tested and such sample(s) are retained for 30 days only.
Attention: To check the authenticity of testing /inspection report & certificate, please contact us at telephone: (86-755) 8307 1443, or email: CN.Doccheck@sgs.com

5 Equipment List

Conducted Emissions at Mains Terminals (150kHz-30MHz)					
Equipment	Manufacturer	Model No	Inventory No	Cal Date	Cal Due Date
Shielding Room	ChangZhou ZhongYu	8m x 3m x 3.8m	EMC0306	N/A	N/A
Two-Line V-Netwok	Rohde & Schwarz	ENV216	EMC0118	2020-01-10	2021-01-09
LISN	Rohde & Schwarz	ENV216	EMC2135	2019-09-16	2020-09-15
EMI Test Receiver	Rohde & Schwarz	ESCS30	EMC0506	2019-11-18	2020-11-17
Coaxial Cable	HangTianXing	2m	EMC0107	2018-09-20	2020-09-19
Voltage Probe	SGS-EMC	N/A	EMC0106	2019-05-10	2021-05-09
Conical Metal Housing	SGS-EMC	N/A	EMC0167	2020-04-19	2022-04-18
Test Software E3c	Audix	Ver. 5.4.1221b	GZE100-62	N/A	N/A

Disturbance Power					
Equipment	Manufacturer	Model No	Inventory No	Cal Date	Cal Due Date
Shielding Room	ChangZhou ZhongYu	8m x 3m x 3.8m	EMC0306	N/A	N/A
EMI Test Receiver	Rohde & Schwarz	ESCS30	EMC0506	2019-11-18	2020-11-17
Absorbing Clamp	Beijing Dazhe Co. Ltd.	ZN23201	EMC2040	2020-01-14	2021-01-13
Absorbing Clamp	Rohde & Schwarz	MDS-21	EMC2184	2020-03-02	2021-03-01
6 dB Attenuator with 8m length cable	Rohde & Schwarz	MDS-21	EMC2185	2020-03-02	2021-03-01
Slide Bar Controller	HD-GmbH	HD50	EMC0305	N/A	N/A
Slide Bar RP	HD-GmbH	KMS560	EMC0103	N/A	N/A
Test Software E3c	Audix	Ver. 5.4.1221b	GZE100-62	N/A	N/A

Harmonic current emission, Voltage Fluctuations and Flicker					
Equipment	Manufacturer	Model No	Inventory No	Cal Date	Cal Due Date
AC Power Source	California	50001iX	EMC0608	2020-03-27	2021-03-26
Power Analyzer	California	PACS	EMC0607	2020-03-27	2021-03-26
Test Software CTS4	California	Ver 4.14.0	GZE100-66	N/A	N/A

Electrostatic Discharge					
Equipment	Manufacturer	Model No	Inventory No	Cal Date	Cal Due Date
ESD Simulator	TESEQ AG	NSG 435	EMC2071	2019-07-04	2020-07-03
ESD Simulator	EMTEST	NX30	EMC2186	2020-03-02	2021-03-01
ESD Ground Plane	SGS-EMC	3m x 3m	EMC0804	N/A	N/A
Temperature & Humidity	Shanghai Meteorological Instrument Factory Co., Ltd.	ZJ1-2B	EMC0078	2019-07-05	2020-07-04



Unless otherwise agreed in writing, this document is issued by the Company subject to its General Conditions of Service printed overleaf, available on request or accessible at <http://www.sgs.com/en/Terms-and-Conditions.aspx> and, for electronic format documents, subject to Terms and Conditions for Electronic Documents at <http://www.sgs.com/en/Terms-and-Conditions/Terms-e-Documents.aspx>. Attention is drawn to the limitation of liability, indemnification and jurisdiction issues defined therein. Any holder of this document is advised that information contained hereon reflects the Company's findings at the time of its intervention only and within the limits of Client's instructions, if any. The Company's sole responsibility is to its Client and this document does not exonerate parties to a transaction from exercising all their rights and obligations under the transaction documents. This document cannot be reproduced except in full, without prior written approval of the Company. Any unauthorized alteration, forgery or falsification of the content or appearance of this document is unlawful and offenders may be prosecuted to the fullest extent of the law. Unless otherwise stated the results shown in this test report refer only to the sample(s) tested and such sample(s) are retained for 30 days only.

Attention: To check the authenticity of testing / inspection report & certificate, please contact us at telephone: (86-755) 8307 1443, or email: CN.Doccheck@sgs.com

Radiated Immunity (80MHz-1GHz)					
Equipment	Manufacturer	Model No	Inventory No	Cal Date	Cal Due Date
Compact 3m Semi-Anechoic Chamber	ChangZhou ZhongYu	N/A	EMC0525	2019-10-20	2022-10-19
Laser Probe Interface	RF Microwave Instrumentation	FI7000	EMC2089	N/A	N/A
Open Switch And Control Unit	Rohde & Schwarz	OSP130	EMC2090	N/A	N/A
Broadband Amplifier(80MHz~1GHz/250W)	Rohde & Schwarz	BBA150	EMC2091	2020-01-10	2021-01-09
Broadband Amplifier(800MHz~3GHz/110W)	Rohde & Schwarz	BBA150	EMC2092	2020-01-10	2021-01-09
Signal Generator	Rohde & Schwarz	SMB100A	EMC2093	2020-01-10	2021-01-09
Laser Probe	RF Microwave Instrumentation	FL7006	EMC2094	2020-03-02	2021-03-21
NRP-Z91 Power Sensor 6GHz	Rohde & Schwarz	NPR-Z91	EMC2095	2020-01-10	2021-01-09
NRP-Z91 Power Sensor 6GHz	Rohde & Schwarz	NPR-Z91	EMC2096	2020-01-10	2021-01-09
High-Gain Log-periodic Antenna	Rohde & Schwarz	HL046E	EMC2097	2019-02-15	2022-02-14
Stacked Logarithmic-Periodic Broadband Antenna (0.7~9GHz)/300W	SCHWARZBECK MESS - ELEKTRONIK	STLP 9149	SEM003-21	2018-09-18	2021-09-17
Broadband Amplifier (2.5~6GHz/30W)	Rohde & Schwarz	BBA150	EMC2105	2019-09-16	2020-09-15
RI Cable	Rohde & Schwarz	7m	EMC2098	2019-05-24	2020-05-23
Oscilloscope	Tektronix	TDS3052C	EMC2055	2020-01-10	2021-01-09
Audio Analyzer	Keysight	U8903B	EMC2180	2019-09-30	2020-09-29
Monitor System	Mitsubish Corp.	M-0552AB	EMC0909	N/A	N/A
Test Software EMC32	Rohde & Schwarz	Ver. 9.26.00	GZE100-63	N/A	N/A

Electrical Fast Transients/Burst at Power Port					
Equipment	Manufacturer	Model No	Inventory No	Cal Date	Cal Due Date
EMC Immunity Test System	TESEQ AG	NSG 3060CDN30611 NA 6502 CIBCND3425	EMC2072	2020-01-10	2021-01-09
Oscilloscope	Tektronix	TDS3052C	EMC2055	2020-01-10	2021-01-09
Test Software WIN 3000	TESEQ AG	Ver 1.3.2	GZE100-68	N/A	N/A



Unless otherwise agreed in writing, this document is issued by the Company subject to its General Conditions of Service printed overleaf, available on request or accessible at <http://www.sgs.com/en/Terms-and-Conditions.aspx> and, for electronic format documents, subject to Terms and Conditions for Electronic Documents at <http://www.sgs.com/en/Terms-and-Conditions/Terms-e-Documents.aspx>. Attention is drawn to the limitation of liability, indemnification and jurisdiction issues defined therein. Any holder of this document is advised that information contained hereon reflects the Company's findings at the time of its intervention only and within the limits of Client's instructions, if any. The Company's sole responsibility is to its Client and this document does not exonerate parties to a transaction from exercising all their rights and obligations under the transaction documents. This document cannot be reproduced except in full, without prior written approval of the Company. Any unauthorized alteration, forgery or falsification of the content or appearance of this document is unlawful and offenders may be prosecuted to the fullest extent of the law. Unless otherwise stated the results shown in this test report refer only to the sample(s) tested and such sample(s) are retained for 30 days only.

Surge at Power Port					
Equipment	Manufacturer	Model No	Inventory No	Cal Date	Cal Due Date
Modular Impulse Surge Generator	EMC PARTNER	MIG0603EN	EMC2059	2020-01-10	2021-01-09
EMC Immunity Test System	TESEQ AG	NSG 3060CDN30611 NA 6502 CIBCND3425	EMC2072	2020-01-10	2021-01-09
Oscilloscope	Tektronix	TDS3052C	EMC2055	2020-01-10	2021-01-09
Test Software WIN 3000	TESEQ AG	Ver 1.3.2	GZE100-68	N/A	N/A

Voltage Dips and Interruptions					
Equipment	Manufacturer	Model No	Inventory No	Cal Date	Cal Due Date
EMC Immunity Test System	TESEQ AG	NSG 3060CDN30611 NA 6502 CIBCND3425	EMC2072	2020-01-10	2021-01-09
Oscilloscope	Tektronix	TDS3052C	EMC2055	2020-01-10	2021-01-09
Test Software WIN 3000	TESEQ AG	Ver 1.3.2	GZE100-68	N/A	N/A

Conducted Immunity at Power Port (150kHz-230MHz)					
Equipment	Manufacturer	Model No	Inventory No	Cal Date	Cal Due Date
Test System for Conducted and Radiated Immunity	TESEQ AG	NSG 4070B-80	EMC2115	2019-07-04	2020-07-04
Test Software NSG4070_Ctrl1	TESEQ AG	Ver.1.3.0.1	GZE100-72	N/A	N/A
CDN S502A	TESEQ AG	CDN S502A	EMC2113	2019-07-13	2021-07-12
CDN ST08A	TESEQ AG	CDN ST08A	EMC2112	2019-07-13	2021-07-12
CDN USB3.0	TESEQ AG	CDN USB3.0	EMC2114	2019-07-13	2021-07-12
Dual Directional coupler	Werlatone Inc.	C1795	EMC1105	2019-06-11	2020-06-10
Oscilloscope	Tektronix	TDS3052C	EMC2055	2020-01-10	2021-01-09
CDN	Elektronik-Feinmechanik	L-801:M2/M3	EMC2048	2018-08-13	2020-08-13
CDN M2	Schaffner Chase	CDN-M2-16	EMC1107	2017-10-26	2020-10-25
Current Probe	Schaffner Chase	CIP9136	EMC1116	2017-10-26	2020-10-25
Current Probe	Schaffner Chase	CSP8445	EMC1117	2017-10-26	2020-10-25
Audio Analyzer	Keysight	U8903B	EMC2180	2019-09-30	2020-09-29

General used equipment					
Equipment	Manufacturer	Model No	Inventory No	Cal Date	Cal Due Date
DMM	Fluke	73	EMC0006	2019-07-16	2020-07-15
DMM	Fluke	73	EMC0007	2019-07-16	2020-07-15



Unless otherwise agreed in writing, this document is issued by the Company subject to its General Conditions of Service printed overleaf, available on request or accessible at <http://www.sgs.com/en/Terms-and-Conditions.aspx> and, for electronic format documents, subject to Terms and Conditions for Electronic Documents at <http://www.sgs.com/en/Terms-and-Conditions/Terms-e-Documents.aspx>. Attention is drawn to the limitation of liability, indemnification and jurisdiction issues defined therein. Any holder of this document is advised that information contained hereon reflects the Company's findings at the time of its intervention only and within the limits of Client's instructions, if any. The Company's sole responsibility is to its Client and this document does not exonerate parties to a transaction from exercising all their rights and obligations under the transaction documents. This document cannot be reproduced except in full, without prior written approval of the Company. Any unauthorized alteration, forgery or falsification of the content or appearance of this document is unlawful and offenders may be prosecuted to the fullest extent of the law. Unless otherwise stated the results shown in this test report refer only to the sample(s) tested and such sample(s) are retained for 30 days only.

Attention: To check the authenticity of testing /inspection report & certificate, please contact us at telephone: (86-755) 8307 1443, or email: CN.Doccheck@sgs.com

6 Emission Test Results

6.1 Conducted Emissions at Mains Terminals (150kHz-30MHz)

Test Requirement:	EN 55014-1:2017
Test Method:	CISPR 16-2-1
Frequency Range:	150kHz to 30MHz
Limit:	
0.15M-0.5MHz	66dB(μV)-56dB(μV) quasi-peak, 59dB(μV)-46dB(μV) average
0.5M-5MHz	56dB(μV) quasi-peak, 46dB(μV) average
5M-30MHz	60dB(μV) quasi-peak, 50dB(μV) average
Detector:	Peak for pre-scan (9kHz resolution bandwidth) 0.15M to 30MHz

6.1.1 E.U.T. Operation

Operating Environment:

Temperature: 23.8 °C Humidity: 52 % RH Atmospheric Pressure: 1020 mbar

Pre test these modes to find the worst case:

- a: Test the EUT in normal working and setting the fan running with high speed mode.
- b: Test the EUT in normal working and setting the fan running with middle speed mode.
- c: Test the EUT in normal working and setting the fan running with low speed mode.

The worst case for final test: a: Test the EUT in normal working and setting the fan running with high speed mode.

6.1.2 Test Setup Diagram

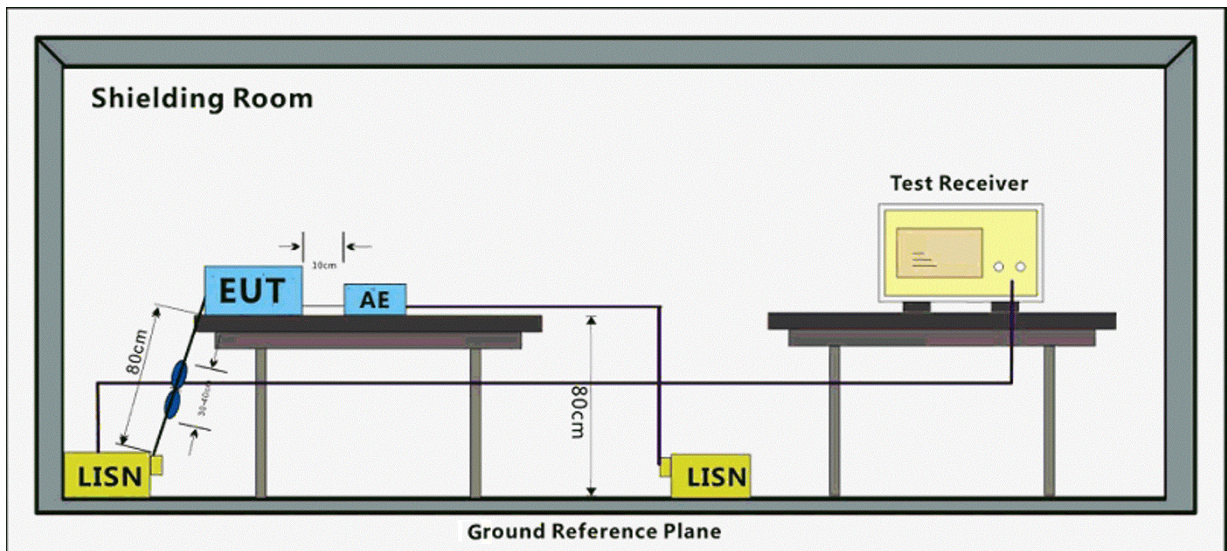

6.1.3 Measurement Data

An initial pre-scan was performed with peak detector. Quasi-Peak or Average measurement were performed at the frequencies with maximized peak emission were detected.

Measured Level = Read level + Cable Loss + LISN Factor



Unless otherwise agreed in writing, this document is issued by the Company subject to its General Conditions of Service printed overleaf, available on request or accessible at <http://www.sgs.com/en/Terms-and-Conditions.aspx> and, for electronic format documents, subject to Terms and Conditions for Electronic Documents at <http://www.sgs.com/en/Terms-and-Conditions/Terms-e-Documents.aspx>. Attention is drawn to the limitation of liability, indemnification and jurisdiction issues defined therein. Any holder of this document is advised that information contained hereon reflects the Company's findings at the time of its intervention only and within the limits of Client's instructions, if any. The Company's sole responsibility is to its Client and this document does not exonerate parties to a transaction from exercising all their rights and obligations under the transaction documents. This document cannot be reproduced except in full, without prior written approval of the Company. Any unauthorized alteration, forgery or falsification of the content or appearance of this document is unlawful and offenders may be prosecuted to the fullest extent of the law. Unless otherwise stated the results shown in this test report refer only to the sample(s) tested and such sample(s) are retained for 30 days only.
Attention: To check the authenticity of testing /inspection report & certificate, please contact us at telephone: (86-755) 8307 1443, or email: CN.Doccheck@sgs.com

Mode:a; Line:Live Line

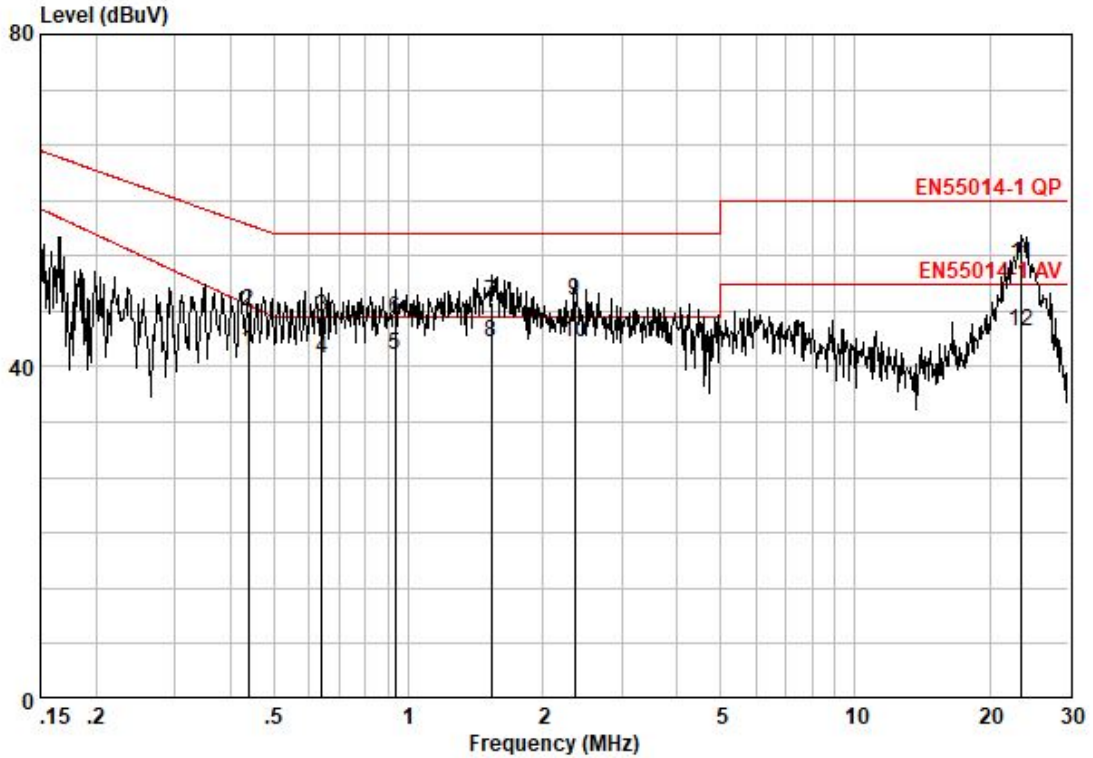

Pol :LIVE
No :
Model :

Frequency MHz	read level dBuV	Cable Loss dB	LISN Factor dB	Measured level dBuV	Limit Line dBuV	Over limit dB	Remark
0.44	31.98	0.10	9.66	41.74	47.44	-5.70	AVERAGE
0.44	36.81	0.10	9.66	46.57	57.11	-10.54	QP
0.64	36.13	0.10	9.67	45.90	56.00	-10.10	QP
0.64	31.17	0.10	9.67	40.94	46.00	-5.06	AVERAGE
0.93	31.70	0.10	9.67	41.47	46.00	-4.53	AVERAGE
0.93	35.95	0.10	9.67	45.72	56.00	-10.28	QP
1.54	37.90	0.10	9.68	47.68	56.00	-8.32	QP
1.54	33.22	0.10	9.68	43.00	46.00	-3.00	AVERAGE
2.36	38.17	0.14	9.69	48.00	56.00	-8.00	QP
2.36	33.17	0.14	9.69	43.00	46.00	-3.00	AVERAGE
23.64	42.22	0.40	9.80	52.42	60.00	-7.58	QP
23.64	34.14	0.40	9.80	44.34	50.00	-5.66	AVERAGE



Unless otherwise agreed in writing, this document is issued by the Company subject to its General Conditions of Service printed overleaf, available on request or accessible at <http://www.sgs.com/en/Terms-and-Conditions.aspx> and, for electronic format documents, subject to Terms and Conditions for Electronic Documents at <http://www.sgs.com/en/Terms-and-Conditions/Terms-e-Document.aspx>. Attention is drawn to the limitation of liability, indemnification and jurisdiction issues defined therein. Any holder of this document is advised that information contained hereon reflects the Company's findings at the time of its intervention only and within the limits of Client's instructions, if any. The Company's sole responsibility is to its Client and this document does not exonerate parties to a transaction from exercising all their rights and obligations under the transaction documents. This document cannot be reproduced except in full, without prior written approval of the Company. Any unauthorized alteration, forgery or falsification of the content or appearance of this document is unlawful and offenders may be prosecuted to the fullest extent of the law. Unless otherwise stated the results shown in this test report refer only to the sample(s) tested and such sample(s) are retained for 30 days only.
Attention: To check the authenticity of testing /inspection report & certificate, please contact us at telephone: (86-755) 8307 1443, or email: CN.Doccheck@sgs.com

Mode:a; Line:Neutral Line

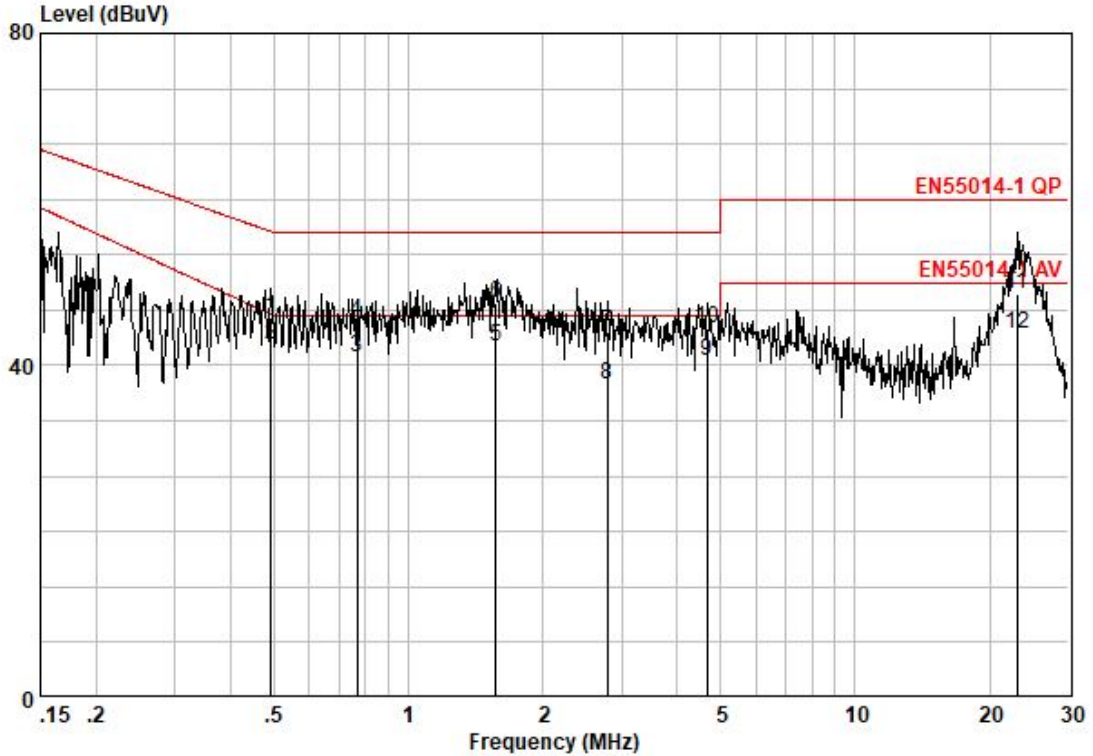

Pol : NEUTRAL
No :
Model :

Frequency MHz	read level dBuV	Cable Loss dB	LISN Factor dB	Measured level dBuV	Limit Line dBuV	Over limit dB	Remark
0.49	36.01	0.10	9.60	45.71	56.14	-10.43	QP
0.49	32.78	0.10	9.60	42.48	46.19	-3.71	AVERAGE
0.77	31.17	0.10	9.61	40.88	46.00	-5.12	AVERAGE
0.77	35.73	0.10	9.61	45.44	56.00	-10.56	QP
1.57	32.67	0.10	9.61	42.38	46.00	-3.62	AVERAGE
1.57	37.74	0.10	9.61	47.45	56.00	-8.55	QP
2.79	34.19	0.18	9.62	43.99	56.00	-12.01	QP
2.79	27.89	0.18	9.62	37.69	46.00	-8.31	AVERAGE
4.67	30.71	0.20	9.64	40.55	46.00	-5.45	AVERAGE
4.67	34.67	0.20	9.64	44.51	56.00	-11.49	QP
23.02	38.15	0.40	10.01	48.56	60.00	-11.44	QP
23.02	33.51	0.40	10.01	43.92	50.00	-6.08	AVERAGE



Unless otherwise agreed in writing, this document is issued by the Company subject to its General Conditions of Service printed overleaf, available on request or accessible at <http://www.sgs.com/en/Terms-and-Conditions.aspx> and, for electronic format documents, subject to Terms and Conditions for Electronic Documents at <http://www.sgs.com/en/Terms-and-Conditions/Terms-e-Documents.aspx>. Attention is drawn to the limitation of liability, indemnification and jurisdiction issues defined therein. Any holder of this document is advised that information contained hereon reflects the Company's findings at the time of its intervention only and within the limits of Client's instructions, if any. The Company's sole responsibility is to its Client and this document does not exonerate parties to a transaction from exercising all their rights and obligations under the transaction documents. This document cannot be reproduced except in full, without prior written approval of the Company. Any unauthorized alteration, forgery or falsification of the content or appearance of this document is unlawful and offenders may be prosecuted to the fullest extent of the law. Unless otherwise stated the results shown in this test report refer only to the sample(s) tested and such sample(s) are retained for 30 days only.
Attention: To check the authenticity of testing / inspection report & certificate, please contact us at telephone: (86-755) 8307 1443, or email: CN.Doccheck@sgs.com

6.2 Disturbance Power

Test Requirement: EN 55014-1:2017
 Test Method: CISPR 16-2-2
 Frequency Range: 30MHz to 300MHz
 Limit:
 30MHz- 300MHz 45dB(pw)-55dB(pw) quasi-peak, 35dB(pw)-45dB(pw) average
 Detector: Peak for pre-scan (120kHz resolution bandwidth) 30M to 300MHz

6.2.1 E.U.T. Operation

Operating Environment:
 Temperature: 24.5 °C Humidity: 52 % RH Atmospheric Pressure: 1020 mbar
 Pre test these modes to find the worst case:
 a: Test the EUT in normal working and setting the fan running with high speed mode.
 b: Test the EUT in normal working and setting the fan running with middle speed mode.
 c: Test the EUT in normal working and setting the fan running with low speed mode.
 The worst case for final test:
 a: Test the EUT in normal working and setting the fan running with high speed mode.

6.2.2 Test Setup Diagram

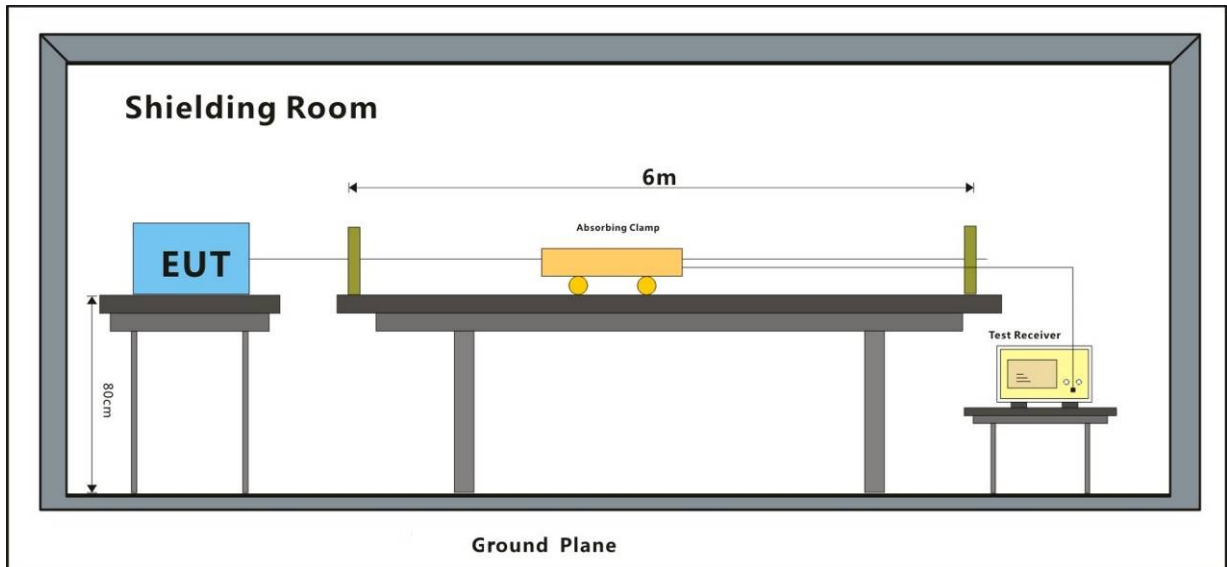

6.2.3 Measurement Data

An initial pre-scan was performed with peak detector. Quasi-Peak or Average measurement were performed at the frequencies with maximized peak emission were detected.

Measured Level = Read level + Cable Loss + Clamp Factor



Unless otherwise agreed in writing, this document is issued by the Company subject to its General Conditions of Service printed overleaf, available on request or accessible at <http://www.sgs.com/en/Terms-and-Conditions.aspx> and, for electronic format documents, subject to Terms and Conditions for Electronic Documents at <http://www.sgs.com/en/Terms-and-Conditions/Terms-e-Document.aspx>. Attention is drawn to the limitation of liability, indemnification and jurisdiction issues defined therein. Any holder of this document is advised that information contained hereon reflects the Company's findings at the time of its intervention only and within the limits of Client's instructions, if any. The Company's sole responsibility is to its Client and this document does not exonerate parties to a transaction from exercising all their rights and obligations under the transaction documents. This document cannot be reproduced except in full, without prior written approval of the Company. Any unauthorized alteration, forgery or falsification of the content or appearance of this document is unlawful and offenders may be prosecuted to the fullest extent of the law. Unless otherwise stated the results shown in this test report refer only to the sample(s) tested and such sample(s) are retained for 30 days only.
Attention: To check the authenticity of testing /inspection report & certificate, please contact us at telephone: (86-755) 8307 1443, or email: CN.Doccheck@sgs.com

Mode:a
Level(dBpW)

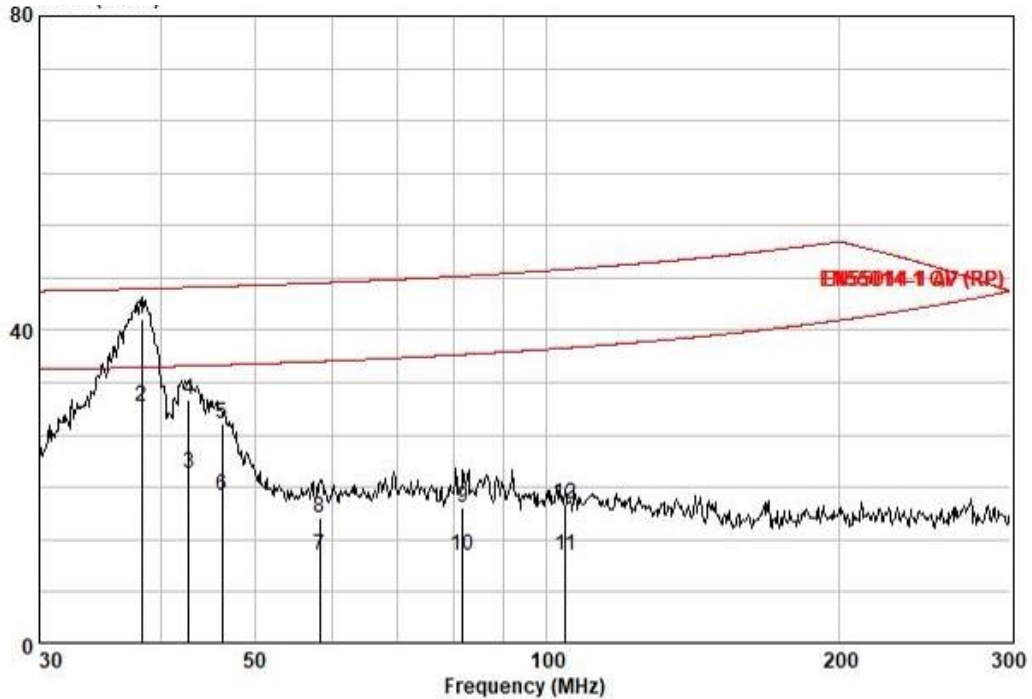

No :
Mode :

Frequency MHz	Read level dBuV	Cable Loss dB	Clamp Factor dBpW/dBuV	Measured level dBpW	Limit Line dBpW	Over limit dB	Remark
38.205	33.12	6.97	1.39	41.48	45.30	-3.83	QP
38.205	22.00	6.97	1.39	30.36	35.30	-4.95	AVERAGE
42.768	14.07	7.00	0.81	21.88	35.47	-13.59	AVERAGE
42.768	23.35	7.00	0.81	31.16	45.47	-14.31	QP
46.251	20.26	7.00	0.85	28.11	45.60	-17.49	QP
46.251	11.11	7.00	0.85	18.96	35.60	-16.64	AVERAGE
58.361	3.88	7.10	0.40	11.38	36.05	-24.67	AVERAGE
58.361	8.71	7.10	0.40	16.21	46.05	-29.84	QP
81.869	10.30	7.20	0.02	17.52	46.92	-29.40	QP
81.869	4.19	7.20	0.02	11.41	36.92	-25.51	AVERAGE
104.501	4.77	7.30	-0.64	11.43	37.76	-26.33	AVERAGE
104.501	11.12	7.30	-0.64	17.78	47.76	-29.98	QP



Unless otherwise agreed in writing, this document is issued by the Company subject to its General Conditions of Service printed overleaf, available on request or accessible at <http://www.sgs.com/en/Terms-and-Conditions.aspx> and, for electronic format documents, subject to Terms and Conditions for Electronic Documents at <http://www.sgs.com/en/Terms-and-Conditions/Terms-e-Documents.aspx>. Attention is drawn to the limitation of liability, indemnification and jurisdiction issues defined therein. Any holder of this document is advised that information contained hereon reflects the Company's findings at the time of its intervention only and within the limits of Client's instructions, if any. The Company's sole responsibility is to its Client and this document does not exonerate parties to a transaction from exercising all their rights and obligations under the transaction documents. This document cannot be reproduced except in full, without prior written approval of the Company. Any unauthorized alteration, forgery or falsification of the content or appearance of this document is unlawful and offenders may be prosecuted to the fullest extent of the law. Unless otherwise stated the results shown in this test report refer only to the sample(s) tested and such sample(s) are retained for 30 days only.

Attention: To check the authenticity of testing / inspection report & certificate, please contact us at telephone: (86-755) 8307 1443, or email: CN.Doccheck@sgs.com
 SGS-CSTC Standards Technical Services Co., Ltd. No.198 Kezhu Road, Sciotech Park, Guangzhou Economic & Technology Development District, Guangzhou, China 510663 t (86-20) 82155555 f (86-20) 82075058 www.sgs.com
 Guangzhou Branch Testing Center EEC Laboratory. 中国·广州·经济技术开发区科学城科珠路198号 邮编: 510663 t (86-20) 82155555 f (86-20) 82075058 sgs.china@sgs.com

6.3 Harmonic Current Emission

Test Requirement: EN IEC 61000-3-2:2019
 Test Method: EN IEC 61000-3-2:2019
 Frequency Range: 100Hz to 2kHz

6.3.1 E.U.T. Operation

Operating Environment:

Temperature: 25.7 °C Humidity: 58 % RH Atmospheric Pressure: 1020 mbar

Pre test these modes to find the worst case:
 a: Test the EUT in normal working and setting the fan running with high speed mode.
 b: Test the EUT in normal working and setting the fan running with middle speed mode.
 c: Test the EUT in normal working and setting the fan running with low speed mode.

The worst case for final test: a: Test the EUT in normal working and setting the fan running with high speed mode

6.3.2 Test Setup Diagram

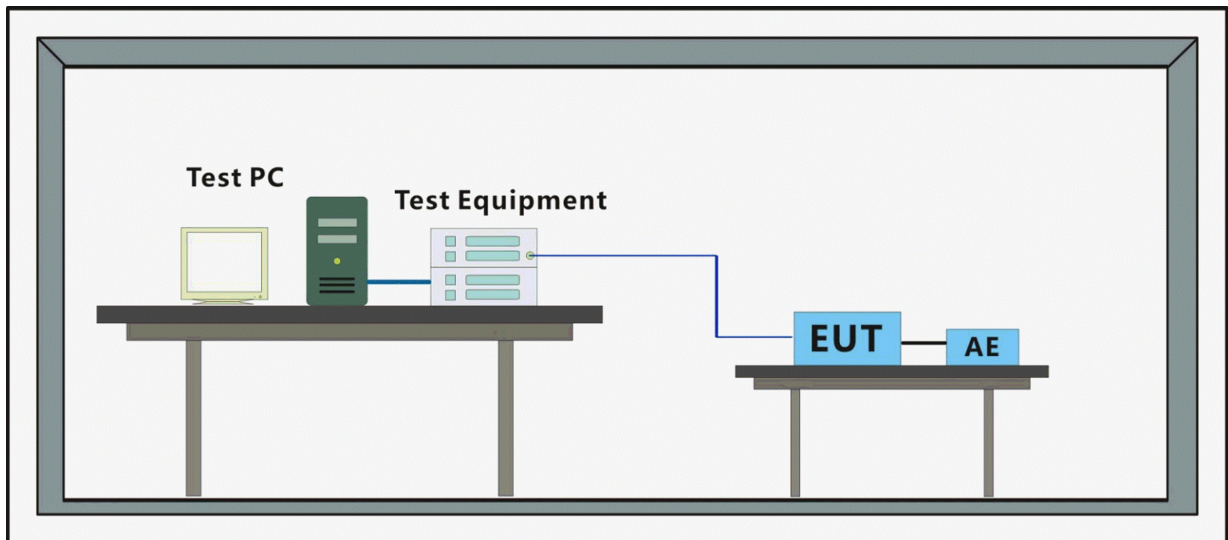

Unless otherwise agreed in writing, this document is issued by the Company subject to its General Conditions of Service printed overleaf, available on request or accessible at <http://www.sgs.com/en/Terms-and-Conditions.aspx> and, for electronic format documents, subject to Terms and Conditions for Electronic Documents at <http://www.sgs.com/en/Terms-and-Conditions/Terms-e-Document.aspx>. Attention is drawn to the limitation of liability, indemnification and jurisdiction issues defined therein. Any holder of this document is advised that information contained hereon reflects the Company's findings at the time of its intervention only and within the limits of Client's instructions, if any. The Company's sole responsibility is to its Client and this document does not exonerate parties to a transaction from exercising all their rights and obligations under the transaction documents. This document cannot be reproduced except in full, without prior written approval of the Company. Any unauthorized alteration, forgery or falsification of the content or appearance of this document is unlawful and offenders may be prosecuted to the fullest extent of the law. Unless otherwise stated the results shown in this test report refer only to the sample(s) tested and such sample(s) are retained for 30 days only.
Attention: To check the authenticity of testing /inspection report & certificate, please contact us at telephone: (86-755) 8307 1443, or email: CN.Doccheck@sgs.com

6.3.3 Measurement Data

Mode:a

Harmonics – Class-A per Ed. Ed. 5.0 (2018)(Run time)

Test category: Class-A per Ed. 5.0 (2018) (European limits) Test Margin: 100
 Test duration (min): 2.5

Test Result: Pass Source qualification: Normal

Current & voltage waveforms

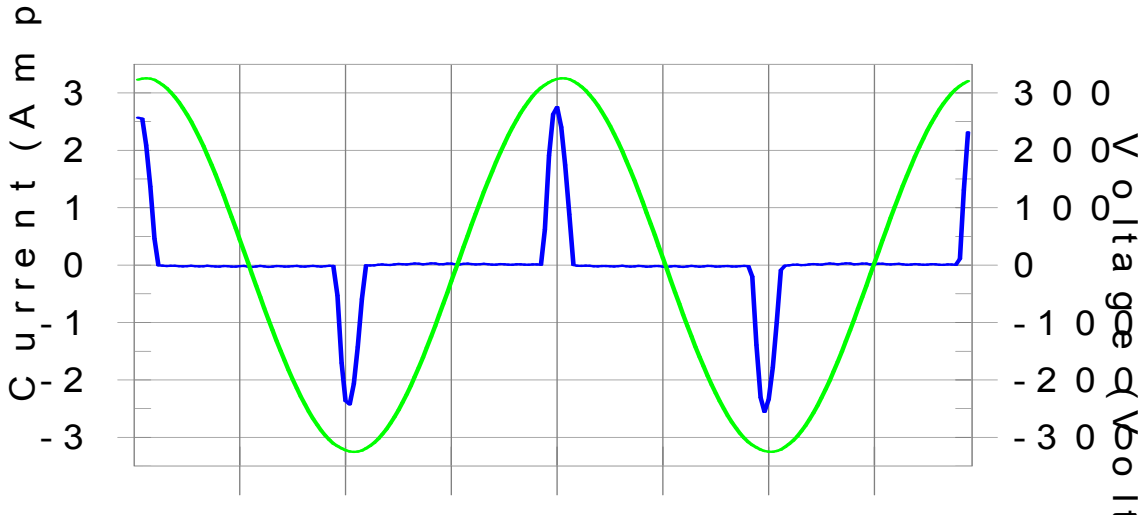

Harmonics and Class A limit line European Limits

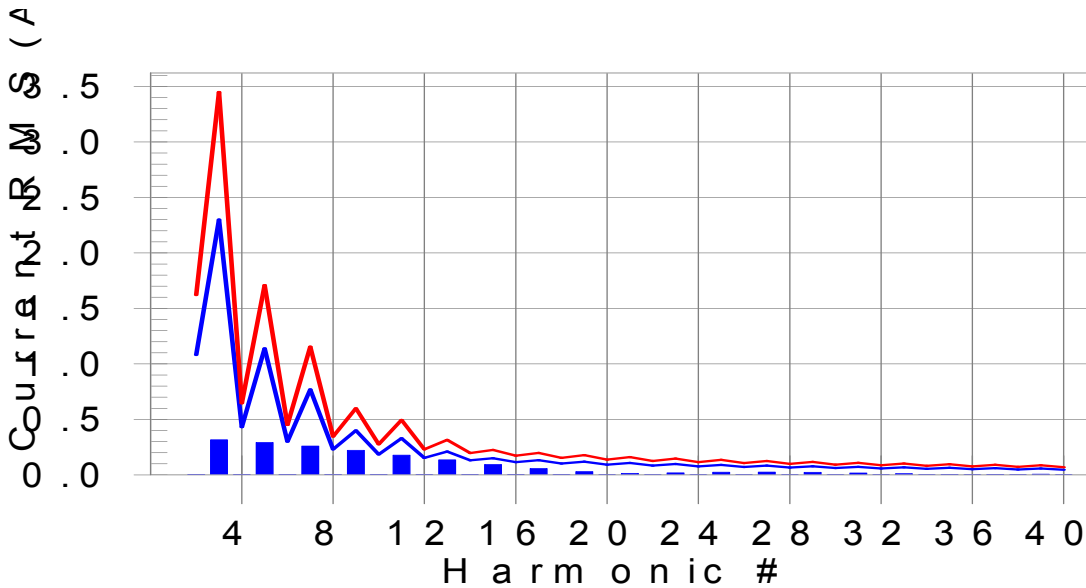

Test result: Pass Worst harmonics H13-43.2% of 150% limit, H13-64.4% of 100% limit



Unless otherwise agreed in writing, this document is issued by the Company subject to its General Conditions of Service printed overleaf, available on request or accessible at <http://www.sgs.com/en/Terms-and-Conditions.aspx> and, for electronic format documents, subject to Terms and Conditions for Electronic Documents at <http://www.sgs.com/en/Terms-and-Conditions/Terms-e-Document.aspx>. Attention is drawn to the limitation of liability, indemnification and jurisdiction issues defined therein. Any holder of this document is advised that information contained hereon reflects the Company's findings at the time of its intervention only and within the limits of Client's instructions, if any. The Company's sole responsibility is to its Client and this document does not exonerate parties to a transaction from exercising all their rights and obligations under the transaction documents. This document cannot be reproduced except in full, without prior written approval of the Company. Any unauthorized alteration, forgery or falsification of the content or appearance of this document is unlawful and offenders may be prosecuted to the fullest extent of the law. Unless otherwise stated the results shown in this test report refer only to the sample(s) tested and such sample(s) are retained for 30 days only.
Attention: To check the authenticity of testing /inspection report & certificate, please contact us at telephone: (86-755) 8307 1443, or email: CN.Doccheck@sgs.com

Current Test Result Summary (Run time)

Test category: Class-A per Ed. 5.0 (2018) (European limits) Test Margin: 100
 Test duration (min): 2.5

Test Result: Pass Source qualification: Normal
 THC(A): 0.607 I-THD(%): 183.5 POHC(A): 0.053 POHC Limit(A): 0.251

Highest parameter values during test:

V_RMS (Volts): 230.00	Frequency(Hz): 50.00
I_Peak (Amps): 2.773	I_RMS (Amps): 0.696
I_Fund (Amps): 0.331	Crest Factor: 4.006
Power (Watts): 75.6	Power Factor: 0.475

Harm#	Harms(avg)	100%Limit	%of Limit	Harms(max)	150%Limit	%of Limit	Status
2	0.003	1.080	N/A	0.005	1.620	N/A	Pass
3	0.317	2.300	13.8	0.319	3.450	9.2	Pass
4	0.003	0.430	N/A	0.004	0.645	N/A	Pass
5	0.293	1.140	25.7	0.294	1.710	17.2	Pass
6	0.003	0.300	N/A	0.005	0.450	N/A	Pass
7	0.260	0.770	33.8	0.261	1.155	22.6	Pass
8	0.003	0.230	N/A	0.004	0.345	N/A	Pass
9	0.221	0.400	55.3	0.222	0.600	37.0	Pass
10	0.002	0.184	N/A	0.003	0.276	N/A	Pass
11	0.178	0.330	54.1	0.179	0.495	36.2	Pass
12	0.002	0.153	N/A	0.003	0.230	N/A	Pass
13	0.135	0.210	64.4	0.136	0.315	43.2	Pass
14	0.001	0.131	N/A	0.002	0.197	N/A	Pass
15	0.094	0.150	62.8	0.095	0.225	42.3	Pass
16	0.001	0.115	N/A	0.002	0.173	N/A	Pass
17	0.058	0.132	43.9	0.059	0.198	29.8	Pass
18	0.001	0.102	N/A	0.001	0.153	N/A	Pass
19	0.029	0.118	24.8	0.030	0.178	16.9	Pass
20	0.001	0.092	N/A	0.001	0.138	N/A	Pass
21	0.014	0.107	13.0	0.014	0.161	8.8	Pass
22	0.001	0.084	N/A	0.001	0.125	N/A	Pass
23	0.018	0.098	18.7	0.019	0.147	12.7	Pass
24	0.001	0.077	N/A	0.001	0.115	N/A	Pass
25	0.024	0.090	27.1	0.025	0.135	18.2	Pass
26	0.001	0.071	N/A	0.001	0.107	N/A	Pass
27	0.026	0.083	31.0	0.026	0.125	20.7	Pass
28	0.001	0.066	N/A	0.001	0.099	N/A	Pass
29	0.023	0.078	29.6	0.023	0.116	19.9	Pass
30	0.001	0.061	N/A	0.001	0.092	N/A	Pass
31	0.017	0.073	23.9	0.018	0.109	16.1	Pass
32	0.000	0.058	N/A	0.001	0.086	N/A	Pass
33	0.010	0.068	15.2	0.011	0.102	10.5	Pass
34	0.000	0.054	N/A	0.001	0.081	N/A	Pass
35	0.004	0.064	N/A	0.004	0.096	N/A	Pass
36	0.000	0.051	N/A	0.001	0.077	N/A	Pass
37	0.003	0.061	N/A	0.004	0.091	N/A	Pass
38	0.000	0.048	N/A	0.001	0.073	N/A	Pass
39	0.007	0.058	12.1	0.007	0.087	8.3	Pass
40	0.000	0.046	N/A	0.001	0.069	N/A	Pass



Unless otherwise agreed in writing, this document is issued by the Company subject to its General Conditions of Service printed overleaf, available on request or accessible at <http://www.sgs.com/en/Terms-and-Conditions.aspx> and, for electronic format documents, subject to Terms and Conditions for Electronic Documents at <http://www.sgs.com/en/Terms-and-Conditions/Terms-e-Document.aspx>. Attention is drawn to the limitation of liability, indemnification and jurisdiction issues defined therein. Any holder of this document is advised that information contained hereon reflects the Company's findings at the time of its intervention only and within the limits of Client's instructions, if any. The Company's sole responsibility is to its Client and this document does not exonerate parties to a transaction from exercising all their rights and obligations under the transaction documents. This document cannot be reproduced except in full, without prior written approval of the Company. Any unauthorized alteration, forgery or falsification of the content or appearance of this document is unlawful and offenders may be prosecuted to the fullest extent of the law. Unless otherwise stated the results shown in this test report refer only to the sample(s) tested and such sample(s) are retained for 30 days only.

Attention: To check the authenticity of testing / inspection report & certificate, please contact us at telephone: (86-755) 8307 1443, or email: CN.Doccheck@sgs.com
 No.198 Kezhu Road, Sciencetech Park, Guangzhou Economic & Technology Development District, Guangzhou, China 510663 t (86-20) 82155555 f (86-20) 82075058 www.sgs.com
 中国·广州·经济技术开发区科学城科珠路198号 邮编: 510663 t (86-20) 82155555 f (86-20) 82075058 sgs.china@sgs.com

6.4 Voltage Fluctuations and Flicker

Test Requirement: EN 61000-3-3:2013 +A1:2019

Test Method: EN 61000-3-3:2013 +A1:2019

6.4.1 E.U.T. Operation

Operating Environment:

Temperature: 25.7 °C Humidity: 58 % RH Atmospheric Pressure: 1020 mbar

Pre test these modes to find the worst case:

- a: Test the EUT in normal working and setting the fan running with high speed mode.
- b: Test the EUT in normal working and setting the fan running with middle speed mode.
- c: Test the EUT in normal working and setting the fan running with low speed mode.

The worst case for final test:

- a: Test the EUT in normal working and setting the fan running with high speed mode.

6.4.2 Test Setup Diagram

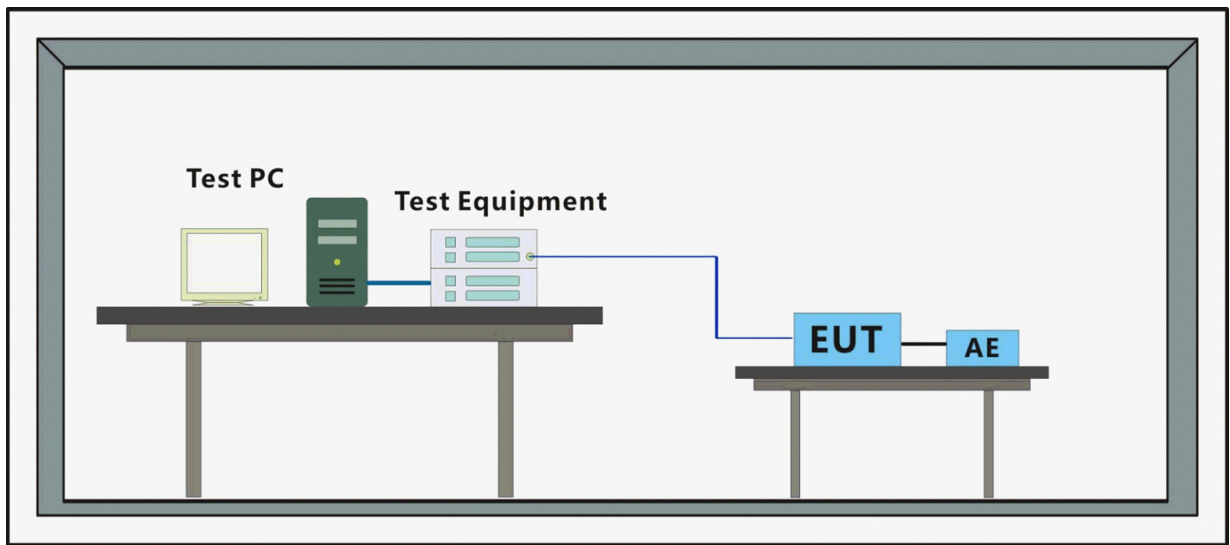

Unless otherwise agreed in writing, this document is issued by the Company subject to its General Conditions of Service printed overleaf, available on request or accessible at <http://www.sgs.com/en/Terms-and-Conditions.aspx> and, for electronic format documents, subject to Terms and Conditions for Electronic Documents at <http://www.sgs.com/en/Terms-and-Conditions/Terms-e-Document.aspx>. Attention is drawn to the limitation of liability, indemnification and jurisdiction issues defined therein. Any holder of this document is advised that information contained hereon reflects the Company's findings at the time of its intervention only and within the limits of Client's instructions, if any. The Company's sole responsibility is to its Client and this document does not exonerate parties to a transaction from exercising all their rights and obligations under the transaction documents. This document cannot be reproduced except in full, without prior written approval of the Company. Any unauthorized alteration, forgery or falsification of the content or appearance of this document is unlawful and offenders may be prosecuted to the fullest extent of the law. Unless otherwise stated the results shown in this test report refer only to the sample(s) tested and such sample(s) are retained for 30 days only.

Attention: To check the authenticity of testing /inspection report & certificate, please contact us at telephone: (86-755) 8307 1443, or email: CN.Doccheck@sgs.com
 SGS-CSTC Standards Technical Services Co., Ltd. | No.198 Kezhu Road, Sciencetech Park, Guangzhou Economic & Technology Development District, Guangzhou, China 510663 t (86-20) 82155555 f (86-20) 82075058 www.sgs.com.cn
 Guangzhou Branch Testing Center IEC Laboratory. 中国·广州·经济技术开发区科学城科珠路198号 邮编: 510663 t (86-20) 82155555 f (86-20) 82075058 sgs.china@sgs.com

6.4.3 Measurement Data

Mode:a

Flicker Test Summary per EN 61000-3-3 Ed. 3.0 (2013) (Run time)

Test category: dt,dmax,dc and Pst (European limits)

Test Margin: 100

Test duration (min): 10

Test Result: Pass

Status: Test Completed

Pst_i and limit line

European Limits

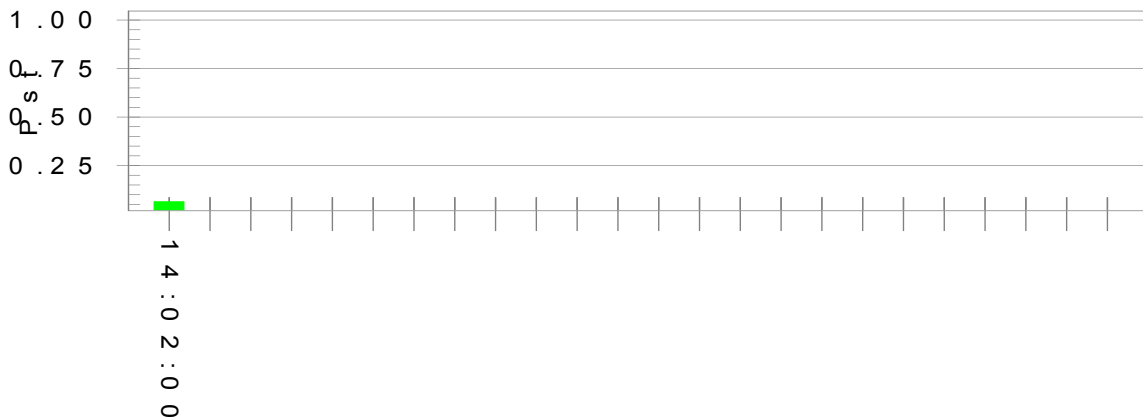

Parameter values recorded during the test:

Vrms at the end of test (Volt):	229.89		
T-max (mS):	0	Test limit (mS):	500.0 Pass
Highest dc (%):	0.00	Test limit (%):	3.30 Pass
Highest dmax (%):	0.00	Test limit (%):	4.00 Pass
Highest Pst (10 min. period):	0.064	Test limit:	1.000 Pass



Unless otherwise agreed in writing, this document is issued by the Company subject to its General Conditions of Service printed overleaf, available on request or accessible at <http://www.sgs.com/en/Terms-and-Conditions.aspx> and, for electronic format documents, subject to Terms and Conditions for Electronic Documents at <http://www.sgs.com/en/Terms-and-Conditions/Terms-e-Document.aspx>. Attention is drawn to the limitation of liability, indemnification and jurisdiction issues defined therein. Any holder of this document is advised that information contained hereon reflects the Company's findings at the time of its intervention only and within the limits of Client's instructions, if any. The Company's sole responsibility is to its Client and this document does not exonerate parties to a transaction from exercising all their rights and obligations under the transaction documents. This document cannot be reproduced except in full, without prior written approval of the Company. Any unauthorized alteration, forgery or falsification of the content or appearance of this document is unlawful and offenders may be prosecuted to the fullest extent of the law. Unless otherwise stated the results shown in this test report refer only to the sample(s) tested and such sample(s) are retained for 30 days only.

Attention: To check the authenticity of testing /inspection report & certificate, please contact us at telephone: (86-755) 8307 1443, or email: CN.Doccheck@sgs.com

SGS-CSTC Standards Technical Services Co., Ltd. No.198 Kezhu Road, Sciencetech Park, Guangzhou Economic & Technology Development District, Guangzhou, China 510663 t (86-20) 82155555 f (86-20) 82075058 www.sgs.com.cn
 Guangzhou Branch Testing Center IEC Laboratory. 中国·广州·经济技术开发区科学城科珠路198号 邮编: 510663 t (86-20) 82155555 f (86-20) 82075058 sgs.china@sgs.com

7 Immunity Test Results

7.1 Performance Criteria Description in EN 55014-2:2015

- Criterion A** The apparatus shall continue to operate as intended during the test. No degradation of performance or loss of function is allowed below a performance level (or permissible loss of performance) specified by the manufacturer, when the apparatus is used as intended. If the minimum performance level or the permissible performance loss is not specified by the manufacturer, then either of these may be derived from the product description and documentation, and from what the user may reasonably expect from the apparatus if used as intended.
- Criterion B** The apparatus shall continue to operate as intended after the test. No degradation of performance or loss of function is allowed below a performance level (or permissible loss of performance) specified by the manufacturer, when the apparatus is used as intended. During the test, degradation of performance is allowed, however. No change of actual operating state or stored data is allowed. If the minimum performance level or the permissible performance loss is not specified by the manufacturer, then either of these may be derived from the product description and documentation and from what the user may reasonably expect from the apparatus if used as intended.
- Criterion C** Temporary loss of function is allowed, provided the function is self recoverable or can be restored by the operation of the controls, or by any operation specified in the instructions for use.



Unless otherwise agreed in writing, this document is issued by the Company subject to its General Conditions of Service printed overleaf, available on request or accessible at <http://www.sgs.com/en/Terms-and-Conditions.aspx> and, for electronic format documents, subject to Terms and Conditions for Electronic Documents at <http://www.sgs.com/en/Terms-and-Conditions/Terms-e-Documents.aspx>. Attention is drawn to the limitation of liability, indemnification and jurisdiction issues defined therein. Any holder of this document is advised that information contained hereon reflects the Company's findings at the time of its intervention only and within the limits of Client's instructions, if any. The Company's sole responsibility is to its Client and this document does not exonerate parties to a transaction from exercising all their rights and obligations under the transaction documents. This document cannot be reproduced except in full, without prior written approval of the Company. Any unauthorized alteration, forgery or falsification of the content or appearance of this document is unlawful and offenders may be prosecuted to the fullest extent of the law. Unless otherwise stated the results shown in this test report refer only to the sample(s) tested and such sample(s) are retained for 30 days only.

Attention: To check the authenticity of testing / inspection report & certificate, please contact us at telephone: (86-755) 8307 1443, or email: CN.Doccheck@sgs.com

7.2 Electrostatic Discharge

Test Requirement:	EN 55014-2:2015
Test Method:	EN 61000-4-2:2009
Performance Criterion:	B
Discharge Impedance:	330Ω/150pF
Number of Discharge:	Minimum 10 times at each test point
Discharge Mode:	Single Discharge
Discharge Period:	1 second minimum

7.2.1 E.U.T. Operation

Operating Environment:

- Temperature: 22.7 °C Humidity: 51 % RH Atmospheric Pressure: 1020 mbar
- Test Mode:
- a: Test the EUT in normal working and setting the fan running with high speed mode.
 - b: Test the EUT in normal working and setting the fan running with middle speed mode.
 - c: Test the EUT in normal working and setting the fan running with low speed mode.
 - d: Test the EUT in idle mode.
 - e: Test the remote controller in continuously emitting mode.

7.2.2 Test Setup Diagram

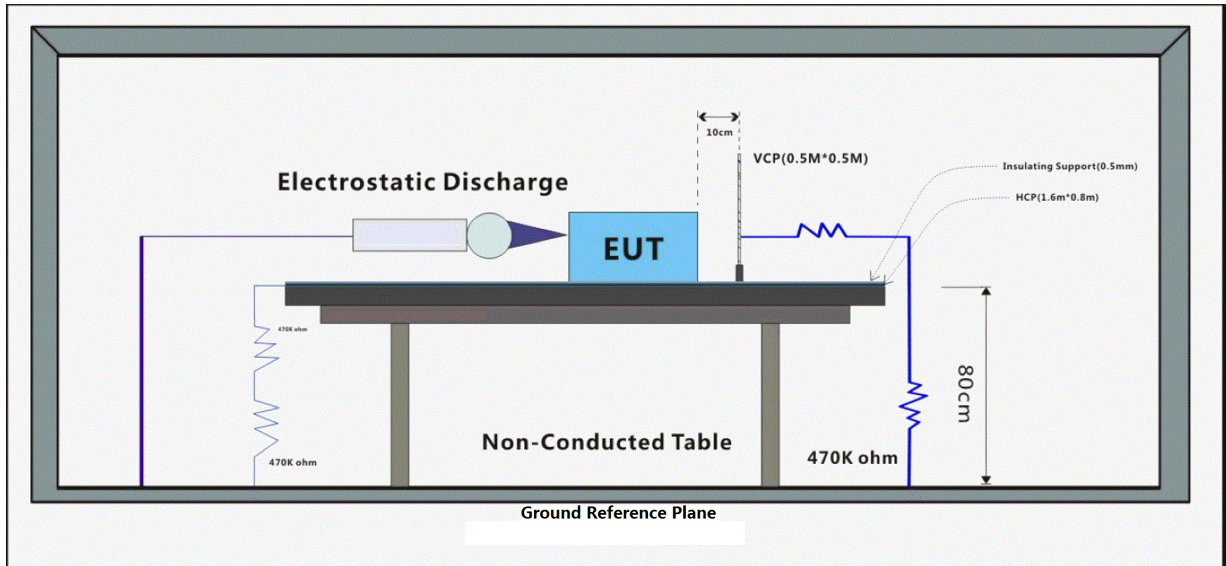

Unless otherwise agreed in writing, this document is issued by the Company subject to its General Conditions of Service printed overleaf, available on request or accessible at <http://www.sgs.com/en/Terms-and-Conditions.aspx> and, for electronic format documents, subject to Terms and Conditions for Electronic Documents at <http://www.sgs.com/en/Terms-and-Conditions/Terms-e-Documents.aspx>. Attention is drawn to the limitation of liability, indemnification and jurisdiction issues defined therein. Any holder of this document is advised that information contained hereon reflects the Company's findings at the time of its intervention only and within the limits of Client's instructions, if any. The Company's sole responsibility is to its Client and this document does not exonerate parties to a transaction from exercising all their rights and obligations under the transaction documents. This document cannot be reproduced except in full, without prior written approval of the Company. Any unauthorized alteration, forgery or falsification of the content or appearance of this document is unlawful and offenders may be prosecuted to the fullest extent of the law. Unless otherwise stated the results shown in this test report refer only to the sample(s) tested and such sample(s) are retained for 30 days only.

Attention: To check the authenticity of testing /inspection report & certificate, please contact us at telephone: (86-755) 8307 1443, or email: CN.Doccheck@sgs.com

SGS-CSTC Standards Technical Services Co., Ltd. No.198 Kezhu Road, Sciencetech Park, Guangzhou Economic & Technology Development District, Guangzhou, China 510663 t (86-20) 82155555 f (86-20) 82075058 www.sgs.com.cn
 Guangzhou Branch Testing Center EEC Laboratory. 中国·广州·经济技术开发区科学城科珠路198号 邮编: 510663 t (86-20) 82155555 f (86-20) 82075058 sgs.china@sgs.com

7.2.3 Test Results

Test Point:

Observations:

1. All insulated enclosure and seams.
2. All accessible metal parts of the enclosure.
3. All side

Discharge type	Level (Kv)	Polarity	Test Point	Result / Observations
Air Discharge	8	+	1	A
Air Discharge	8	-	1	A
Contact Discharge	4	+	2	A
Contact Discharge	4	-	2	A
Horizontal Coupling	4	+	3	N/A
Horizontal Coupling	4	-	3	N/A
Vertical Coupling	4	+	3	A
Vertical Coupling	4	-	3	A

Results:

A: No degradation in the performance of the EUT was observed.

N/A: Not applicable.



Unless otherwise agreed in writing, this document is issued by the Company subject to its General Conditions of Service printed overleaf, available on request or accessible at <http://www.sgs.com/en/Terms-and-Conditions.aspx> and, for electronic format documents, subject to Terms and Conditions for Electronic Documents at <http://www.sgs.com/en/Terms-and-Conditions/Terms-e-Document.aspx>. Attention is drawn to the limitation of liability, indemnification and jurisdiction issues defined therein. Any holder of this document is advised that information contained hereon reflects the Company's findings at the time of its intervention only and within the limits of Client's instructions, if any. The Company's sole responsibility is to its Client and this document does not exonerate parties to a transaction from exercising all their rights and obligations under the transaction documents. This document cannot be reproduced except in full, without prior written approval of the Company. Any unauthorized alteration, forgery or falsification of the content or appearance of this document is unlawful and offenders may be prosecuted to the fullest extent of the law. Unless otherwise stated the results shown in this test report refer only to the sample(s) tested and such sample(s) are retained for 30 days only.
Attention: To check the authenticity of testing /inspection report & certificate, please contact us at telephone: (86-755) 8307 1443, or email: CN.Doccheck@sgs.com

7.3 Radiated Immunity (80MHz-1GHz)

Test Requirement: EN 55014-2:2015
 Test Method: EN 61000-4-3:2006 +A1:2008+A2:2010
 Performance Criterion: A
 Frequency Range: 80MHz to 1GHz
 Antenna Polarisation: Vertical and Horizontal
 Modulation: 1kHz,80% Amp. Mod,1% increment

7.3.1 E.U.T. Operation

Operating Environment:
 Temperature: 23.7 °C Humidity: 52 % RH Atmospheric Pressure: 1020 mbar
 Test Mode:
 d: Test the EUT in idle mode.
 e: Test the remote controller in continuously emitting mode.

7.3.2 Test Setup Diagram

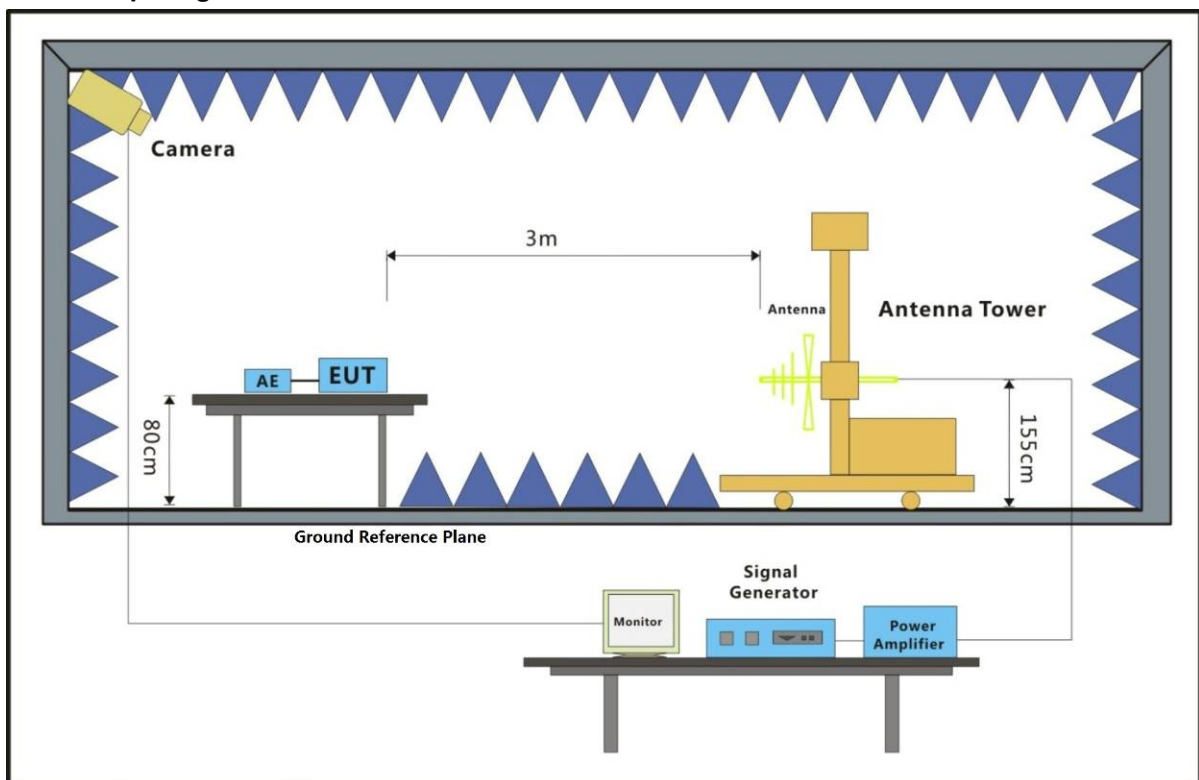

Unless otherwise agreed in writing, this document is issued by the Company subject to its General Conditions of Service printed overleaf, available on request or accessible at <http://www.sgs.com/en/Terms-and-Conditions.aspx> and, for electronic format documents, subject to Terms and Conditions for Electronic Documents at <http://www.sgs.com/en/Terms-and-Conditions/Terms-e-Document.aspx>. Attention is drawn to the limitation of liability, indemnification and jurisdiction issues defined therein. Any holder of this document is advised that information contained hereon reflects the Company's findings at the time of its intervention only and within the limits of Client's instructions, if any. The Company's sole responsibility is to its Client and this document does not exonerate parties to a transaction from exercising all their rights and obligations under the transaction documents. This document cannot be reproduced except in full, without prior written approval of the Company. Any unauthorized alteration, forgery or falsification of the content or appearance of this document is unlawful and offenders may be prosecuted to the fullest extent of the law. Unless otherwise stated the results shown in this test report refer only to the sample(s) tested and such sample(s) are retained for 30 days only.
Attention: To check the authenticity of testing /inspection report & certificate, please contact us at telephone: (86-755) 8307 1443, or email: CN.Doccheck@sgs.com
 No.198 Kezhu Road, Sciencetech Park, Guangzhou Economic & Technology Development District, Guangzhou, China 510663 t (86-20) 82155555 f (86-20) 82075058 www.sgs.com.cn
 Guangzhou Branch Testing Center EEC Laboratory. 中国·广州·经济技术开发区科学城科珠路198号 邮编: 510663 t (86-20) 82155555 f (86-20) 82075058 sgs.china@sgs.com

7.3.3 Test Results

Frequency	Level (V/m)	EUT Face	Dwell time	Result / Observations
80MHz-1GHz	3	Front	2s	A
80MHz-1GHz	3	Back	2s	A
80MHz-1GHz	3	Left	2s	A
80MHz-1GHz	3	Right	2s	A
80MHz-1GHz	3	Top	2s	A
80MHz-1GHz	3	Underside	2s	A

Results:

A: No degradation in the performance of the EUT was observed.



Unless otherwise agreed in writing, this document is issued by the Company subject to its General Conditions of Service printed overleaf, available on request or accessible at <http://www.sgs.com/en/Terms-and-Conditions.aspx> and, for electronic format documents, subject to Terms and Conditions for Electronic Documents at <http://www.sgs.com/en/Terms-and-Conditions/Terms-e-Document.aspx>. Attention is drawn to the limitation of liability, indemnification and jurisdiction issues defined therein. Any holder of this document is advised that information contained hereon reflects the Company's findings at the time of its intervention only and within the limits of Client's instructions, if any. The Company's sole responsibility is to its Client and this document does not exonerate parties to a transaction from exercising all their rights and obligations under the transaction documents. This document cannot be reproduced except in full, without prior written approval of the Company. Any unauthorized alteration, forgery or falsification of the content or appearance of this document is unlawful and offenders may be prosecuted to the fullest extent of the law. Unless otherwise stated the results shown in this test report refer only to the sample(s) tested and such sample(s) are retained for 30 days only.
Attention: To check the authenticity of testing /inspection report & certificate, please contact us at telephone: (86-755) 8307 1443, or email: CN.Doccheck@sgs.com

7.4 Electrical Fast Transients/Burst at Power Port

Test Requirement: EN 55014-2:2015
 Test Method: EN 61000-4-4:2012
 Performance Criterion: B
 Repetition Frequency: 5kHz
 Burst Period: 300ms
 Test Duration: 2 minute per level & polarity

7.4.1 E.U.T. Operation

Operating Environment:

Temperature: 25.5 °C Humidity: 65.9 % RH Atmospheric Pressure: 1020 mbar

Test Mode:
 a: Test the EUT in normal working and setting the fan running with high speed mode.
 b: Test the EUT in normal working and setting the fan running with middle speed mode.
 c: Test the EUT in normal working and setting the fan running with low speed mode.
 d: Test the EUT in idle mode.

7.4.2 Test Setup Diagram

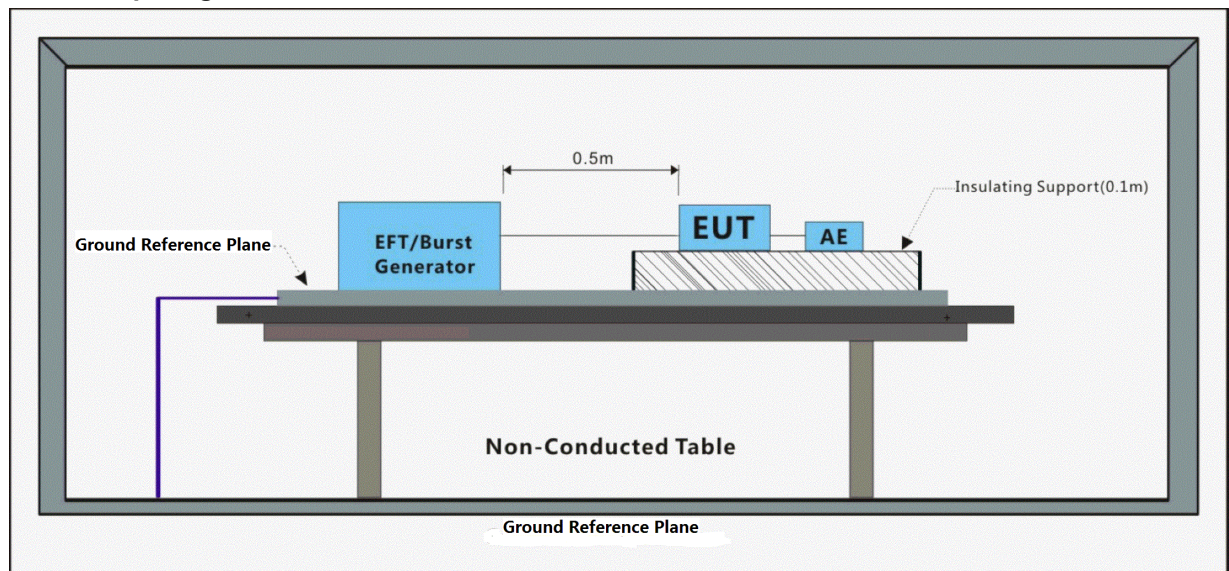

7.4.3 Test Results

Test Line	Level (kV)	Polarity	CDN/Clamp	Result / Observations
AC power port	1	+	CDN	A
AC power port	1	-	CDN	A

Results:

A: No degradation in the performance of the EUT was observed.



Unless otherwise agreed in writing, this document is issued by the Company subject to its General Conditions of Service printed overleaf, available on request or accessible at <http://www.sgs.com/en/Terms-and-Conditions.aspx> and, for electronic format documents, subject to Terms and Conditions for Electronic Documents at <http://www.sgs.com/en/Terms-and-Conditions/Terms-e-Document.aspx>. Attention is drawn to the limitation of liability, indemnification and jurisdiction issues defined therein. Any holder of this document is advised that information contained hereon reflects the Company's findings at the time of its intervention only and within the limits of Client's instructions, if any. The Company's sole responsibility is to its Client and this document does not exonerate parties to a transaction from exercising all their rights and obligations under the transaction documents. This document cannot be reproduced except in full, without prior written approval of the Company. Any unauthorized alteration, forgery or falsification of the content or appearance of this document is unlawful and offenders may be prosecuted to the fullest extent of the law. Unless otherwise stated the results shown in this test report refer only to the sample(s) tested and such sample(s) are retained for 30 days only.
Attention: To check the authenticity of testing / inspection report & certificate, please contact us at telephone: (86-755) 8307 1443, or email: CN.Doccheck@sgs.com

7.5 Surge at Power Port

Test Requirement: EN 55014-2:2015
 Test Method: EN 61000-4-5:2014
 Performance Criterion: B
 Interval: 60s between each surge
 No. of surges: 5 positive at 90°, 5 negative at 270°.

7.5.1 E.U.T. Operation

Operating Environment:
 Temperature: 25.5 °C Humidity: 66.3 % RH Atmospheric Pressure: 1020 mbar
 Test Mode:
 a: Test the EUT in normal working and setting the fan running with high speed mode.
 b: Test the EUT in normal working and setting the fan running with middle speed mode.
 c: Test the EUT in normal working and setting the fan running with low speed mode.
 d: Test the EUT in idle mode.

7.5.2 Test Setup Diagram

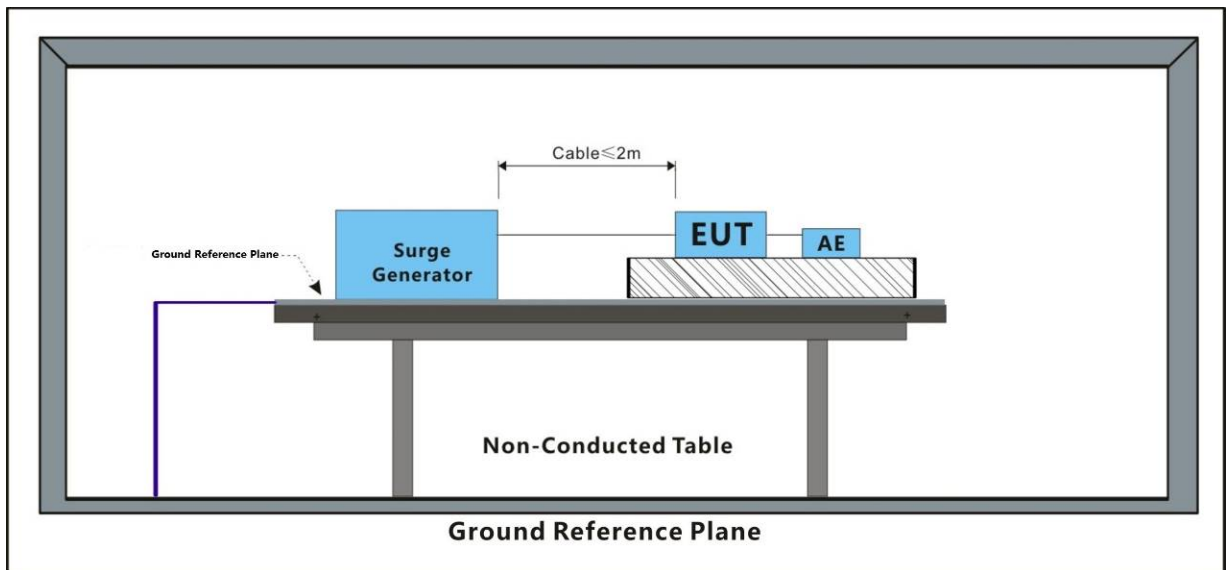

7.5.3 Test Results

Test Line	Level (kV)	Polarity	Phase (deg)	Result / Observations
L-N	1	+	90°	A
L-N	1	-	270°	A

Results:

A: No degradation in the performance of the EUT was observed.



Unless otherwise agreed in writing, this document is issued by the Company subject to its General Conditions of Service printed overleaf, available on request or accessible at <http://www.sgs.com/en/Terms-and-Conditions.aspx> and, for electronic format documents, subject to Terms and Conditions for Electronic Documents at <http://www.sgs.com/en/Terms-and-Conditions/Terms-e-Documents.aspx>. Attention is drawn to the limitation of liability, indemnification and jurisdiction issues defined therein. Any holder of this document is advised that information contained hereon reflects the Company's findings at the time of its intervention only and within the limits of Client's instructions, if any. The Company's sole responsibility is to its Client and this document does not exonerate parties to a transaction from exercising all their rights and obligations under the transaction documents. This document cannot be reproduced except in full, without prior written approval of the Company. Any unauthorized alteration, forgery or falsification of the content or appearance of this document is unlawful and offenders may be prosecuted to the fullest extent of the law. Unless otherwise stated the results shown in this test report refer only to the sample(s) tested and such sample(s) are retained for 30 days only.
Attention: To check the authenticity of testing / inspection report & certificate, please contact us at telephone: (86-755) 8307 1443, or email: CN.Doccheck@sgs.com

7.6 Voltage Dips and Interruptions

Test Requirement: EN 55014-2:2015
 Test Method: EN 61000-4-11:2004
 Performance Criterion: For 50Hz:
 0% of UT (Rated Voltage) for 0.5 Cycle: C;
 40% of UT for 10 Cycle: C;
 70% of UT for 25 Cycle: C

No. of Dips / Interruptions: 3 per Level

Time between dropout 10s

7.6.1 E.U.T. Operation

Operating Environment:

Temperature: 25.5 °C Humidity: 66.6 % RH Atmospheric Pressure: 1020 mbar

Test Mode:
 a: Test the EUT in normal working and setting the fan running with high speed mode.
 b: Test the EUT in normal working and setting the fan running with middle speed mode.
 c: Test the EUT in normal working and setting the fan running with low speed mode.
 d: Test the EUT in idle mode.

7.6.2 Test Setup Diagram

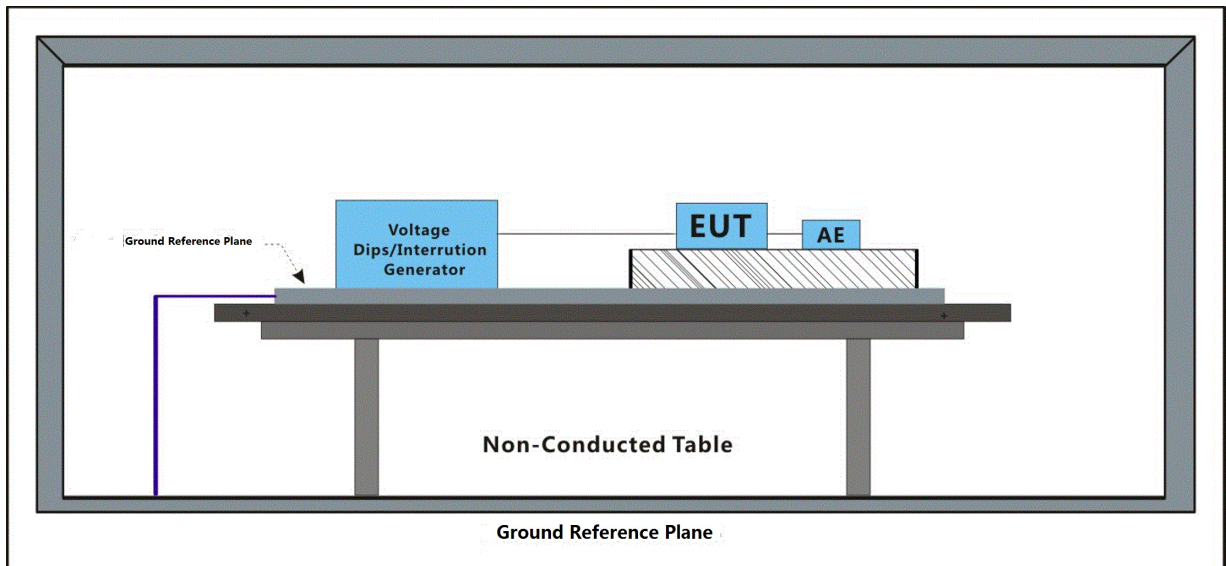

Unless otherwise agreed in writing, this document is issued by the Company subject to its General Conditions of Service printed overleaf, available on request or accessible at <http://www.sgs.com/en/Terms-and-Conditions.aspx> and, for electronic format documents, subject to Terms and Conditions for Electronic Documents at <http://www.sgs.com/en/Terms-and-Conditions/Terms-e-Document.aspx>. Attention is drawn to the limitation of liability, indemnification and jurisdiction issues defined therein. Any holder of this document is advised that information contained hereon reflects the Company's findings at the time of its intervention only and within the limits of Client's instructions, if any. The Company's sole responsibility is to its Client and this document does not exonerate parties to a transaction from exercising all their rights and obligations under the transaction documents. This document cannot be reproduced except in full, without prior written approval of the Company. Any unauthorized alteration, forgery or falsification of the content or appearance of this document is unlawful and offenders may be prosecuted to the fullest extent of the law. Unless otherwise stated the results shown in this test report refer only to the sample(s) tested and such sample(s) are retained for 30 days only.
Attention: To check the authenticity of testing / inspection report & certificate, please contact us at telephone: (86-755) 8307 1443, or email: CN.Doccheck@sgs.com

7.6.3 Test Results

Level % UT	Phase (deg)	Duration	No. of Dips / Interruptions	Result / Observations
0	0°	0.5 Cycles for 50Hz	3	A
0	180°	0.5 Cycles for 50Hz	3	A
40	0°	10 Cycles for 50Hz	3	A
70	0°	25 Cycles for 50Hz	3	A

Results:

A: No degradation in the performance of the EUT was observed.



Unless otherwise agreed in writing, this document is issued by the Company subject to its General Conditions of Service printed overleaf, available on request or accessible at <http://www.sgs.com/en/Terms-and-Conditions.aspx> and, for electronic format documents, subject to Terms and Conditions for Electronic Documents at <http://www.sgs.com/en/Terms-and-Conditions/Terms-e-Documents.aspx>. Attention is drawn to the limitation of liability, indemnification and jurisdiction issues defined therein. Any holder of this document is advised that information contained hereon reflects the Company's findings at the time of its intervention only and within the limits of Client's instructions, if any. The Company's sole responsibility is to its Client and this document does not exonerate parties to a transaction from exercising all their rights and obligations under the transaction documents. This document cannot be reproduced except in full, without prior written approval of the Company. Any unauthorized alteration, forgery or falsification of the content or appearance of this document is unlawful and offenders may be prosecuted to the fullest extent of the law. Unless otherwise stated the results shown in this test report refer only to the sample(s) tested and such sample(s) are retained for 30 days only.
Attention: To check the authenticity of testing /inspection report & certificate, please contact us at telephone: (86-755) 8307 1443, or email: CN.Doccheck@sgs.com

7.7 Conducted Immunity at Power Port (150kHz-230MHz)

Test Requirement: EN 55014-2:2015
 Test Method: EN 61000-4-6:2014
 Performance Criterion: A
 Frequency Range: 0.15MHz to 230MHz
 Modulation: 80%, 1kHz Amplitude Modulation
 Step Size 1%

7.7.1 E.U.T. Operation

Operating Environment:

Temperature: 25.5 °C Humidity: 66.5 % RH Atmospheric Pressure: 1020 mbar

Test Mode: a: Test the EUT in normal working and setting the fan running with high speed mode.
 b: Test the EUT in normal working and setting the fan running with middle speed mode.
 c: Test the EUT in normal working and setting the fan running with low speed mode.
 d: Test the EUT in idle mode.

7.7.2 Test Setup Diagram

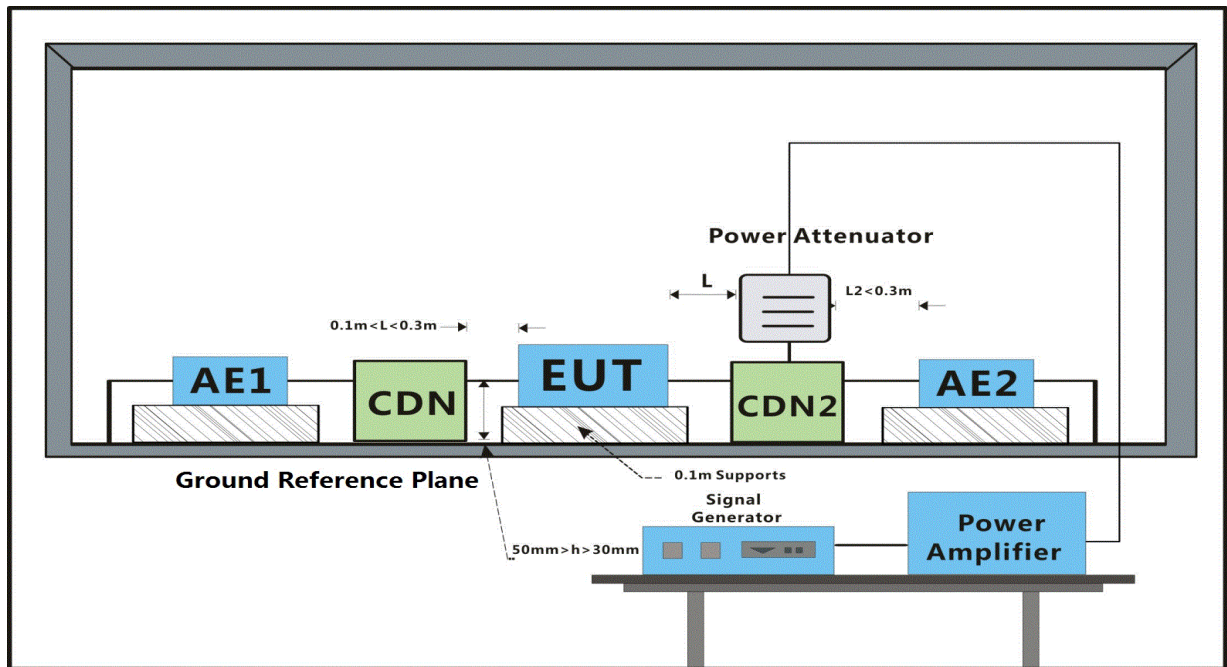

7.7.3 Test Results

Cable port	Level (Vrms)	CDN/Clamp	Dwell time	Result / Observations
AC power port	3	CDN	2s	A

Results:

A: No degradation in the performance of the EUT was observed.



Unless otherwise agreed in writing, this document is issued by the Company subject to its General Conditions of Service printed overleaf, available on request or accessible at <http://www.sgs.com/en/Terms-and-Conditions.aspx> and, for electronic format documents, subject to Terms and Conditions for Electronic Documents at <http://www.sgs.com/en/Terms-and-Conditions/Terms-e-Document.aspx>. Attention is drawn to the limitation of liability, indemnification and jurisdiction issues defined therein. Any holder of this document is advised that information contained hereon reflects the Company's findings at the time of its intervention only and within the limits of Client's instructions, if any. The Company's sole responsibility is to its Client and this document does not exonerate parties to a transaction from exercising all their rights and obligations under the transaction documents. This document cannot be reproduced except in full, without prior written approval of the Company. Any unauthorized alteration, forgery or falsification of the content or appearance of this document is unlawful and offenders may be prosecuted to the fullest extent of the law. Unless otherwise stated the results shown in this test report refer only to the sample(s) tested and such sample(s) are retained for 30 days only.

8 Photographs

8.1 Conducted Emissions at Mains Terminals (150kHz-30MHz) Test Setup



Unless otherwise agreed in writing, this document is issued by the Company subject to its General Conditions of Service printed overleaf, available on request or accessible at <http://www.sgs.com/en/Terms-and-Conditions.aspx> and, for electronic format documents, subject to Terms and Conditions for Electronic Documents at <http://www.sgs.com/en/Terms-and-Conditions/Terms-e-Documents.aspx>. Attention is drawn to the limitation of liability, indemnification and jurisdiction issues defined therein. Any holder of this document is advised that information contained hereon reflects the Company's findings at the time of its intervention only and within the limits of Client's instructions, if any. The Company's sole responsibility is to its Client and this document does not exonerate parties to a transaction from exercising all their rights and obligations under the transaction documents. This document cannot be reproduced except in full, without prior written approval of the Company. Any unauthorized alteration, forgery or falsification of the content or appearance of this document is unlawful and offenders may be prosecuted to the fullest extent of the law. Unless otherwise stated the results shown in this test report refer only to the sample(s) tested and such sample(s) are retained for 30 days only.

Attention: To check the authenticity of testing /inspection report & certificate, please contact us at telephone: (86-755) 8307 1443, or email: CN.Doccheck@sgs.com

8.2 Disturbance Power Test Setup



Unless otherwise agreed in writing, this document is issued by the Company subject to its General Conditions of Service printed overleaf, available on request or accessible at <http://www.sgs.com/en/Terms-and-Conditions.aspx> and, for electronic format documents, subject to Terms and Conditions for Electronic Documents at <http://www.sgs.com/en/Terms-and-Conditions/Terms-e-Document.aspx>. Attention is drawn to the limitation of liability, indemnification and jurisdiction issues defined therein. Any holder of this document is advised that information contained hereon reflects the Company's findings at the time of its intervention only and within the limits of Client's instructions, if any. The Company's sole responsibility is to its Client and this document does not exonerate parties to a transaction from exercising all their rights and obligations under the transaction documents. This document cannot be reproduced except in full, without prior written approval of the Company. Any unauthorized alteration, forgery or falsification of the content or appearance of this document is unlawful and offenders may be prosecuted to the fullest extent of the law. Unless otherwise stated the results shown in this test report refer only to the sample(s) tested and such sample(s) are retained for 30 days only.

Attention: To check the authenticity of testing /inspection report & certificate, please contact us at telephone: (86-755) 8307 1443, or email: CN.Doccheck@sgs.com

8.3 Harmonic current emission, Voltage Fluctuations and Flicker Test Setup



Unless otherwise agreed in writing, this document is issued by the Company subject to its General Conditions of Service printed overleaf, available on request or accessible at <http://www.sgs.com/en/Terms-and-Conditions.aspx> and, for electronic format documents, subject to Terms and Conditions for Electronic Documents at <http://www.sgs.com/en/Terms-and-Conditions/Terms-e-Document.aspx>. Attention is drawn to the limitation of liability, indemnification and jurisdiction issues defined therein. Any holder of this document is advised that information contained hereon reflects the Company's findings at the time of its intervention only and within the limits of Client's instructions, if any. The Company's sole responsibility is to its Client and this document does not exonerate parties to a transaction from exercising all their rights and obligations under the transaction documents. This document cannot be reproduced except in full, without prior written approval of the Company. Any unauthorized alteration, forgery or falsification of the content or appearance of this document is unlawful and offenders may be prosecuted to the fullest extent of the law. Unless otherwise stated the results shown in this test report refer only to the sample(s) tested and such sample(s) are retained for 30 days only.

Attention: To check the authenticity of testing /inspection report & certificate, please contact us at telephone: (86-755) 8307 1443, or email: CN.Doccheck@sgs.com

8.4 Electrostatic Discharge Test Setup



8.5 Radiated Immunity (80MHz-1GHz) Test Setup



Unless otherwise agreed in writing, this document is issued by the Company subject to its General Conditions of Service printed overleaf, available on request or accessible at <http://www.sgs.com/en/Terms-and-Conditions.aspx> and, for electronic format documents, subject to Terms and Conditions for Electronic Documents at <http://www.sgs.com/en/Terms-and-Conditions/Terms-e-Document.aspx>. Attention is drawn to the limitation of liability, indemnification and jurisdiction issues defined therein. Any holder of this document is advised that information contained hereon reflects the Company's findings at the time of its intervention only and within the limits of Client's instructions, if any. The Company's sole responsibility is to its Client and this document does not exonerate parties to a transaction from exercising all their rights and obligations under the transaction documents. This document cannot be reproduced except in full, without prior written approval of the Company. Any unauthorized alteration, forgery or falsification of the content or appearance of this document is unlawful and offenders may be prosecuted to the fullest extent of the law. Unless otherwise stated the results shown in this test report refer only to the sample(s) tested and such sample(s) are retained for 30 days only.

Attention: To check the authenticity of testing /inspection report & certificate, please contact us at telephone: (86-755) 8307 1443, or email: CN.Doccheck@sgs.com

8.6 Electrical Fast Transients/Burst at Power Port Test Setup



Unless otherwise agreed in writing, this document is issued by the Company subject to its General Conditions of Service printed overleaf, available on request or accessible at <http://www.sgs.com/en/Terms-and-Conditions.aspx> and, for electronic format documents, subject to Terms and Conditions for Electronic Documents at <http://www.sgs.com/en/Terms-and-Conditions/Terms-e-Documents.aspx>. Attention is drawn to the limitation of liability, indemnification and jurisdiction issues defined therein. Any holder of this document is advised that information contained hereon reflects the Company's findings at the time of its intervention only and within the limits of Client's instructions, if any. The Company's sole responsibility is to its Client and this document does not exonerate parties to a transaction from exercising all their rights and obligations under the transaction documents. This document cannot be reproduced except in full, without prior written approval of the Company. Any unauthorized alteration, forgery or falsification of the content or appearance of this document is unlawful and offenders may be prosecuted to the fullest extent of the law. Unless otherwise stated the results shown in this test report refer only to the sample(s) tested and such sample(s) are retained for 30 days only.
Attention: To check the authenticity of testing /inspection report & certificate, please contact us at telephone: (86-755) 8307 1443, or email: CN.Doccheck@sgs.com

8.7 Surge at Power Port Test Setup



Unless otherwise agreed in writing, this document is issued by the Company subject to its General Conditions of Service printed overleaf, available on request or accessible at <http://www.sgs.com/en/Terms-and-Conditions.aspx> and, for electronic format documents, subject to Terms and Conditions for Electronic Documents at <http://www.sgs.com/en/Terms-and-Conditions/Terms-e-Document.aspx>. Attention is drawn to the limitation of liability, indemnification and jurisdiction issues defined therein. Any holder of this document is advised that information contained hereon reflects the Company's findings at the time of its intervention only and within the limits of Client's instructions, if any. The Company's sole responsibility is to its Client and this document does not exonerate parties to a transaction from exercising all their rights and obligations under the transaction documents. This document cannot be reproduced except in full, without prior written approval of the Company. Any unauthorized alteration, forgery or falsification of the content or appearance of this document is unlawful and offenders may be prosecuted to the fullest extent of the law. Unless otherwise stated the results shown in this test report refer only to the sample(s) tested and such sample(s) are retained for 30 days only.
Attention: To check the authenticity of testing /inspection report & certificate, please contact us at telephone: (86-755) 8307 1443, or email: CN.Doccheck@sgs.com

8.8 Voltage Dips and Interruptions Test Setup



Unless otherwise agreed in writing, this document is issued by the Company subject to its General Conditions of Service printed overleaf, available on request or accessible at <http://www.sgs.com/en/Terms-and-Conditions.aspx> and, for electronic format documents, subject to Terms and Conditions for Electronic Documents at <http://www.sgs.com/en/Terms-and-Conditions/Terms-e-Document.aspx>. Attention is drawn to the limitation of liability, indemnification and jurisdiction issues defined therein. Any holder of this document is advised that information contained hereon reflects the Company's findings at the time of its intervention only and within the limits of Client's instructions, if any. The Company's sole responsibility is to its Client and this document does not exonerate parties to a transaction from exercising all their rights and obligations under the transaction documents. This document cannot be reproduced except in full, without prior written approval of the Company. Any unauthorized alteration, forgery or falsification of the content or appearance of this document is unlawful and offenders may be prosecuted to the fullest extent of the law. Unless otherwise stated the results shown in this test report refer only to the sample(s) tested and such sample(s) are retained for 30 days only.

Attention: To check the authenticity of testing /inspection report & certificate, please contact us at telephone: (86-755) 8307 1443, or email: CN.Doccheck@sgs.com

8.9 Conducted Immunity at Power Port (150kHz-230MHz) Test Setup



Unless otherwise agreed in writing, this document is issued by the Company subject to its General Conditions of Service printed overleaf, available on request or accessible at <http://www.sgs.com/en/Terms-and-Conditions.aspx> and, for electronic format documents, subject to Terms and Conditions for Electronic Documents at <http://www.sgs.com/en/Terms-and-Conditions/Terms-e-Document.aspx>. Attention is drawn to the limitation of liability, indemnification and jurisdiction issues defined therein. Any holder of this document is advised that information contained hereon reflects the Company's findings at the time of its intervention only and within the limits of Client's instructions, if any. The Company's sole responsibility is to its Client and this document does not exonerate parties to a transaction from exercising all their rights and obligations under the transaction documents. This document cannot be reproduced except in full, without prior written approval of the Company. Any unauthorized alteration, forgery or falsification of the content or appearance of this document is unlawful and offenders may be prosecuted to the fullest extent of the law. Unless otherwise stated the results shown in this test report refer only to the sample(s) tested and such sample(s) are retained for 30 days only.

Attention: To check the authenticity of testing /inspection report & certificate, please contact us at telephone: (86-755) 8307 1443, or email: CN.Doccheck@sgs.com

8.10 EUT Constructional Details



Unless otherwise agreed in writing, this document is issued by the Company subject to its General Conditions of Service printed overleaf, available on request or accessible at <http://www.sgs.com/en/Terms-and-Conditions.aspx> and, for electronic format documents, subject to Terms and Conditions for Electronic Documents at <http://www.sgs.com/en/Terms-and-Conditions/Terms-e-Document.aspx>. Attention is drawn to the limitation of liability, indemnification and jurisdiction issues defined therein. Any holder of this document is advised that information contained hereon reflects the Company's findings at the time of its intervention only and within the limits of Client's instructions, if any. The Company's sole responsibility is to its Client and this document does not exonerate parties to a transaction from exercising all their rights and obligations under the transaction documents. This document cannot be reproduced except in full, without prior written approval of the Company. Any unauthorized alteration, forgery or falsification of the content or appearance of this document is unlawful and offenders may be prosecuted to the fullest extent of the law. Unless otherwise stated the results shown in this test report refer only to the sample(s) tested and such sample(s) are retained for 30 days only.

Attention: To check the authenticity of testing /inspection report & certificate, please contact us at telephone: (86-755) 8307 1443, or email: CN.Doccheck@sgs.com

SGS-CSTC Standards Technical Services Co., Ltd. | No.198 Kezhu Road, Sciencetech Park, Guangzhou Economic & Technology Development District, Guangzhou, China 510663 t (86-20) 82155555 f (86-20) 82075058 www.sgs.com
 Guangzhou Branch Testing Center EEC Laboratory. | 中国·广州·经济技术开发区科学城科珠路198号 邮编: 510663 t (86-20) 82155555 f (86-20) 82075058 sgs.china@sgs.com



Unless otherwise agreed in writing, this document is issued by the Company subject to its General Conditions of Service printed overleaf, available on request or accessible at <http://www.sgs.com/en/Terms-and-Conditions.aspx> and, for electronic format documents, subject to Terms and Conditions for Electronic Documents at <http://www.sgs.com/en/Terms-and-Conditions/Terms-e-Documents.aspx>. Attention is drawn to the limitation of liability, indemnification and jurisdiction issues defined therein. Any holder of this document is advised that information contained hereon reflects the Company's findings at the time of its intervention only and within the limits of Client's instructions, if any. The Company's sole responsibility is to its Client and this document does not exonerate parties to a transaction from exercising all their rights and obligations under the transaction documents. This document cannot be reproduced except in full, without prior written approval of the Company. Any unauthorized alteration, forgery or falsification of the content or appearance of this document is unlawful and offenders may be prosecuted to the fullest extent of the law. Unless otherwise stated the results shown in this test report refer only to the sample(s) tested and such sample(s) are retained for 30 days only.

Attention: To check the authenticity of testing /inspection report & certificate, please contact us at telephone: (86-755) 8307 1443, or email: CN.Doccheck@sgs.com

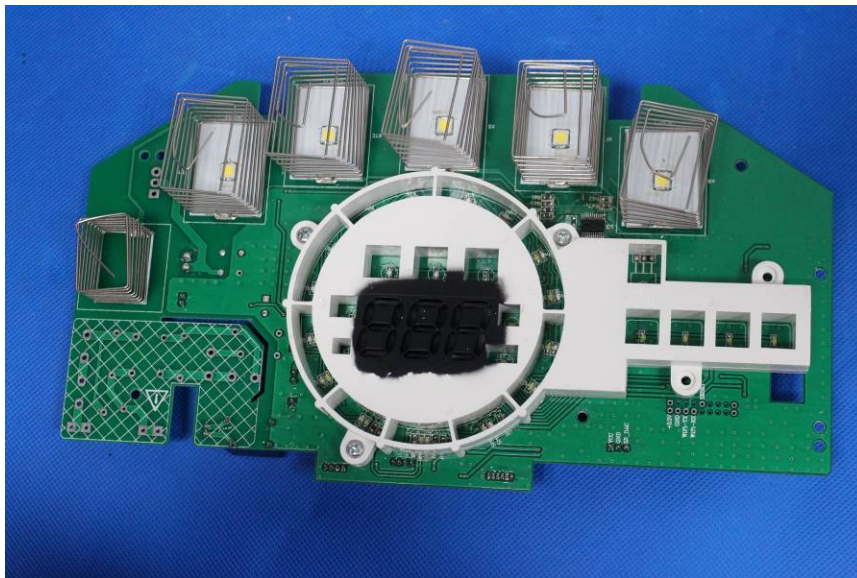
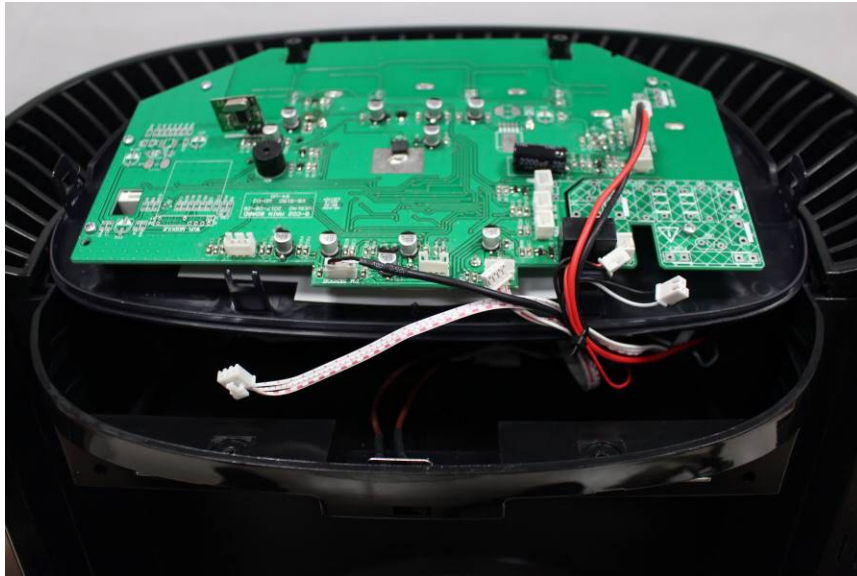

Unless otherwise agreed in writing, this document is issued by the Company subject to its General Conditions of Service printed overleaf, available on request or accessible at <http://www.sgs.com/en/Terms-and-Conditions.aspx> and, for electronic format documents, subject to Terms and Conditions for Electronic Documents at <http://www.sgs.com/en/Terms-and-Conditions/Terms-e-Documents.aspx>. Attention is drawn to the limitation of liability, indemnification and jurisdiction issues defined therein. Any holder of this document is advised that information contained hereon reflects the Company's findings at the time of its intervention only and within the limits of Client's instructions, if any. The Company's sole responsibility is to its Client and this document does not exonerate parties to a transaction from exercising all their rights and obligations under the transaction documents. This document cannot be reproduced except in full, without prior written approval of the Company. Any unauthorized alteration, forgery or falsification of the content or appearance of this document is unlawful and offenders may be prosecuted to the fullest extent of the law. Unless otherwise stated the results shown in this test report refer only to the sample(s) tested and such sample(s) are retained for 30 days only.

Attention: To check the authenticity of testing /inspection report & certificate, please contact us at telephone: (86-755) 8307 1443, or email: CN.Doccheck@sgs.com

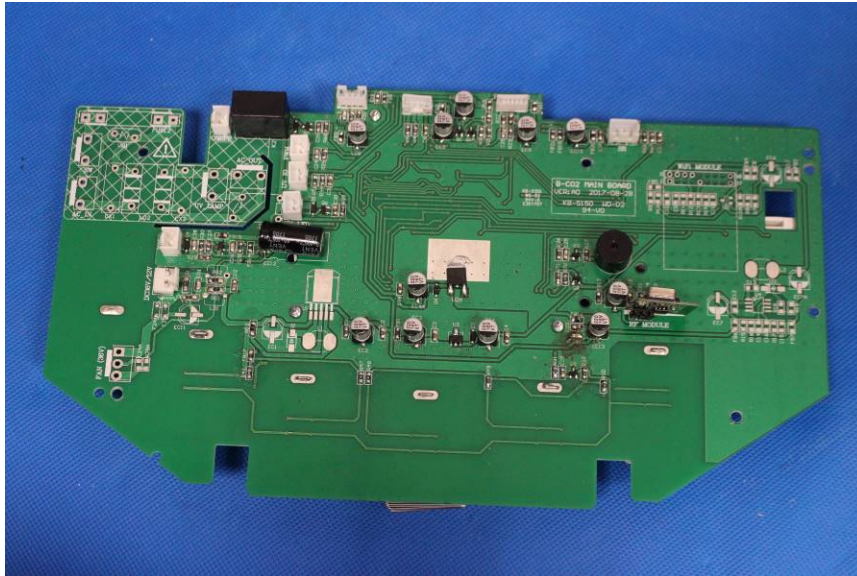

Unless otherwise agreed in writing, this document is issued by the Company subject to its General Conditions of Service printed overleaf, available on request or accessible at <http://www.sgs.com/en/Terms-and-Conditions.aspx> and, for electronic format documents, subject to Terms and Conditions for Electronic Documents at <http://www.sgs.com/en/Terms-and-Conditions/Terms-e-Document.aspx>. Attention is drawn to the limitation of liability, indemnification and jurisdiction issues defined therein. Any holder of this document is advised that information contained hereon reflects the Company's findings at the time of its intervention only and within the limits of Client's instructions, if any. The Company's sole responsibility is to its Client and this document does not exonerate parties to a transaction from exercising all their rights and obligations under the transaction documents. This document cannot be reproduced except in full, without prior written approval of the Company. Any unauthorized alteration, forgery or falsification of the content or appearance of this document is unlawful and offenders may be prosecuted to the fullest extent of the law. Unless otherwise stated the results shown in this test report refer only to the sample(s) tested and such sample(s) are retained for 30 days only.

Attention: To check the authenticity of testing /inspection report & certificate, please contact us at telephone: (86-755) 8307 1443, or email: CN.Doccheck@sgs.com

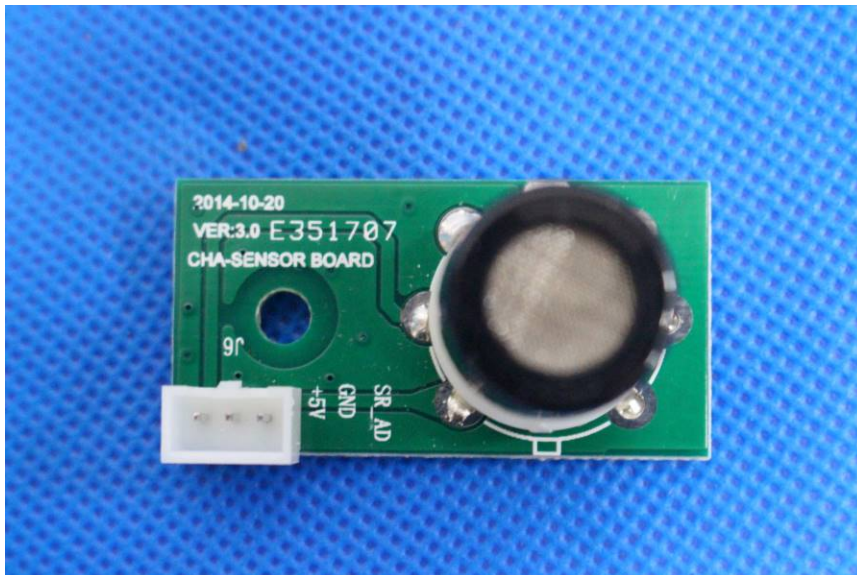
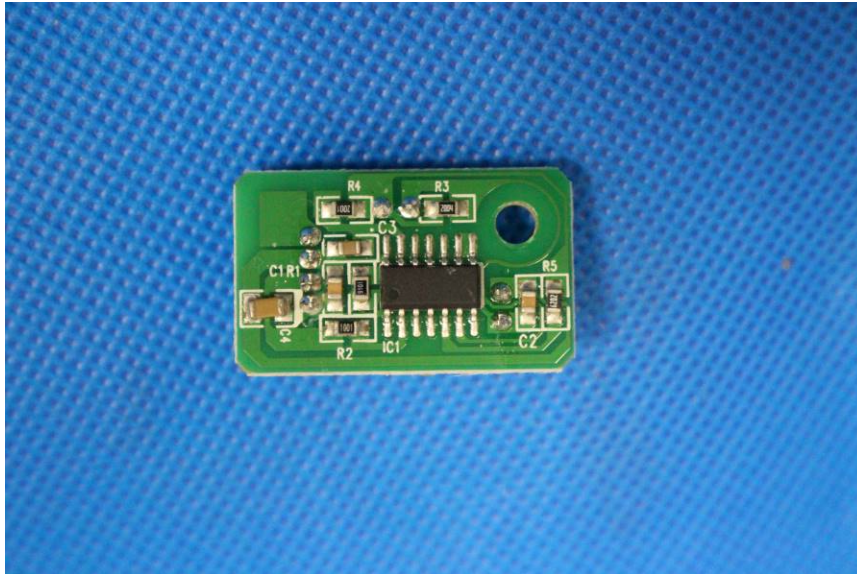

Unless otherwise agreed in writing, this document is issued by the Company subject to its General Conditions of Service printed overleaf, available on request or accessible at <http://www.sgs.com/en/Terms-and-Conditions.aspx> and, for electronic format documents, subject to Terms and Conditions for Electronic Documents at <http://www.sgs.com/en/Terms-and-Conditions/Terms-e-Document.aspx>. Attention is drawn to the limitation of liability, indemnification and jurisdiction issues defined therein. Any holder of this document is advised that information contained hereon reflects the Company's findings at the time of its intervention only and within the limits of Client's instructions, if any. The Company's sole responsibility is to its Client and this document does not exonerate parties to a transaction from exercising all their rights and obligations under the transaction documents. This document cannot be reproduced except in full, without prior written approval of the Company. Any unauthorized alteration, forgery or falsification of the content or appearance of this document is unlawful and offenders may be prosecuted to the fullest extent of the law. Unless otherwise stated the results shown in this test report refer only to the sample(s) tested and such sample(s) are retained for 30 days only.

Attention: To check the authenticity of testing /inspection report & certificate, please contact us at telephone: (86-755) 8307 1443, or email: CN.Doccheck@sgs.com

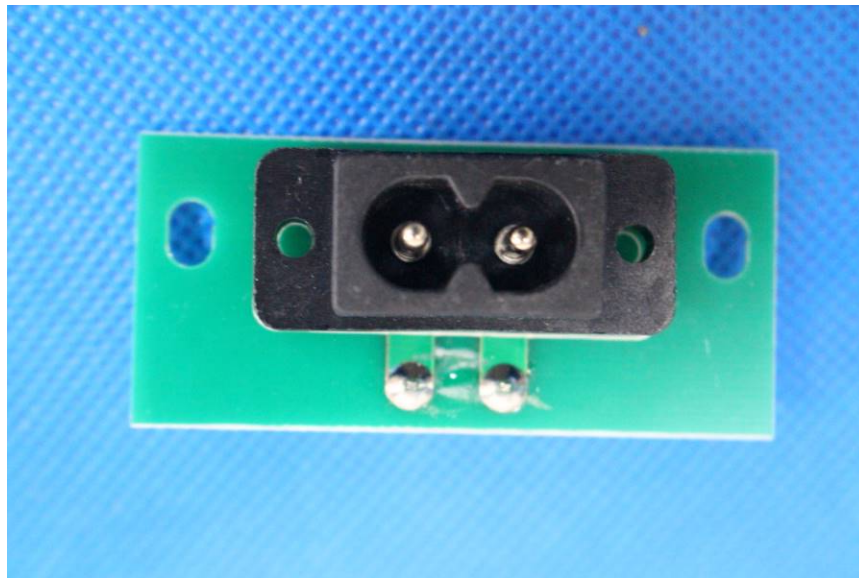
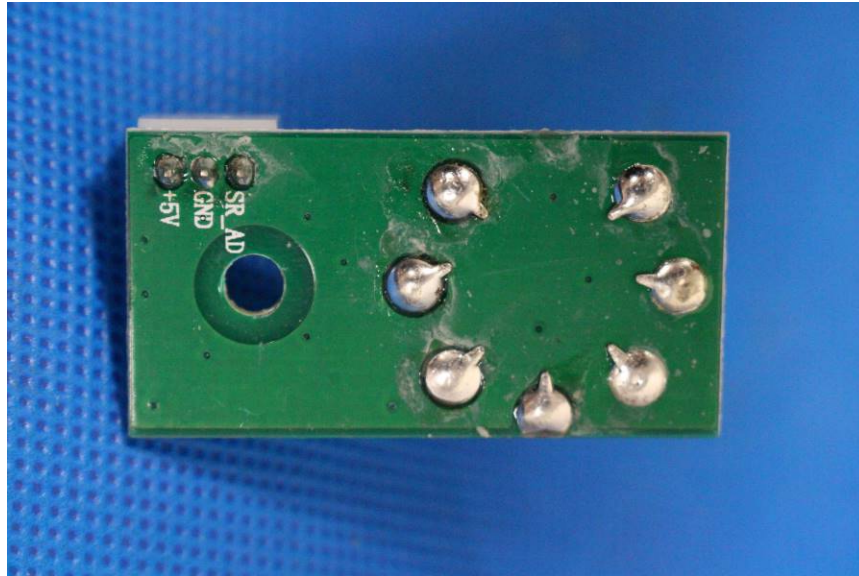

Unless otherwise agreed in writing, this document is issued by the Company subject to its General Conditions of Service printed overleaf, available on request or accessible at <http://www.sgs.com/en/Terms-and-Conditions.aspx> and, for electronic format documents, subject to Terms and Conditions for Electronic Documents at <http://www.sgs.com/en/Terms-and-Conditions/Terms-e-Document.aspx>. Attention is drawn to the limitation of liability, indemnification and jurisdiction issues defined therein. Any holder of this document is advised that information contained hereon reflects the Company's findings at the time of its intervention only and within the limits of Client's instructions, if any. The Company's sole responsibility is to its Client and this document does not exonerate parties to a transaction from exercising all their rights and obligations under the transaction documents. This document cannot be reproduced except in full, without prior written approval of the Company. Any unauthorized alteration, forgery or falsification of the content or appearance of this document is unlawful and offenders may be prosecuted to the fullest extent of the law. Unless otherwise stated the results shown in this test report refer only to the sample(s) tested and such sample(s) are retained for 30 days only.

Attention: To check the authenticity of testing /inspection report & certificate, please contact us at telephone: (86-755) 8307 1443, or email: CN.Doccheck@sgs.com

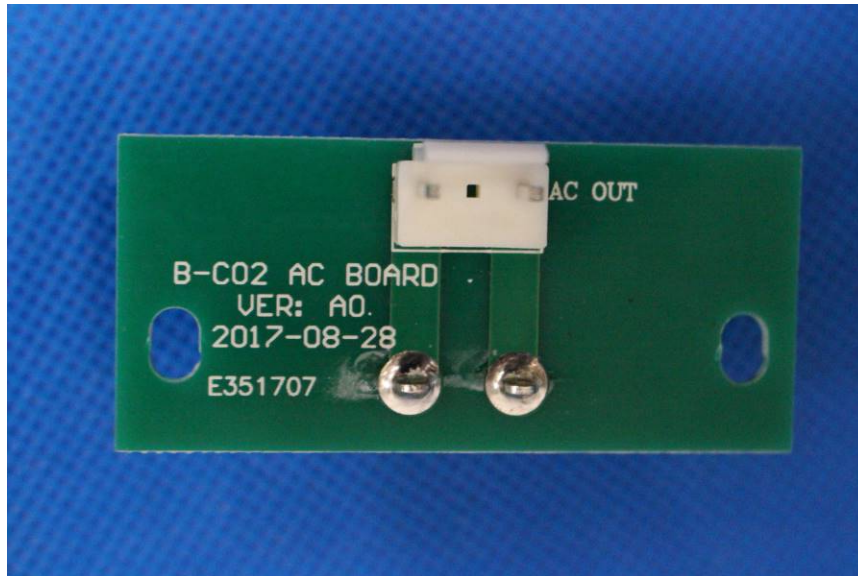

Unless otherwise agreed in writing, this document is issued by the Company subject to its General Conditions of Service printed overleaf, available on request or accessible at <http://www.sgs.com/en/Terms-and-Conditions.aspx> and, for electronic format documents, subject to Terms and Conditions for Electronic Documents at <http://www.sgs.com/en/Terms-and-Conditions/Terms-e-Document.aspx>. Attention is drawn to the limitation of liability, indemnification and jurisdiction issues defined therein. Any holder of this document is advised that information contained hereon reflects the Company's findings at the time of its intervention only and within the limits of Client's instructions, if any. The Company's sole responsibility is to its Client and this document does not exonerate parties to a transaction from exercising all their rights and obligations under the transaction documents. This document cannot be reproduced except in full, without prior written approval of the Company. Any unauthorized alteration, forgery or falsification of the content or appearance of this document is unlawful and offenders may be prosecuted to the fullest extent of the law. Unless otherwise stated the results shown in this test report refer only to the sample(s) tested and such sample(s) are retained for 30 days only.

Attention: To check the authenticity of testing /inspection report & certificate, please contact us at telephone: (86-755) 8307 1443, or email: CN.Doccheck@sgs.com

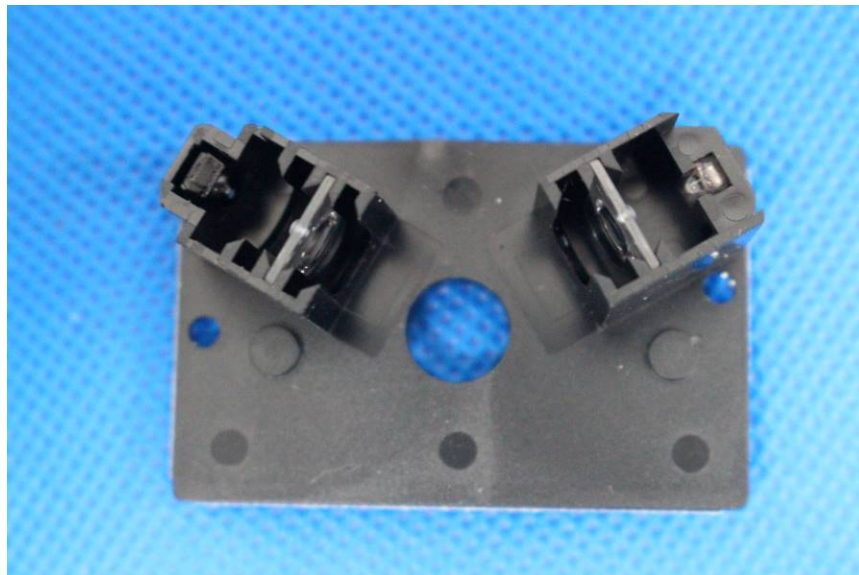
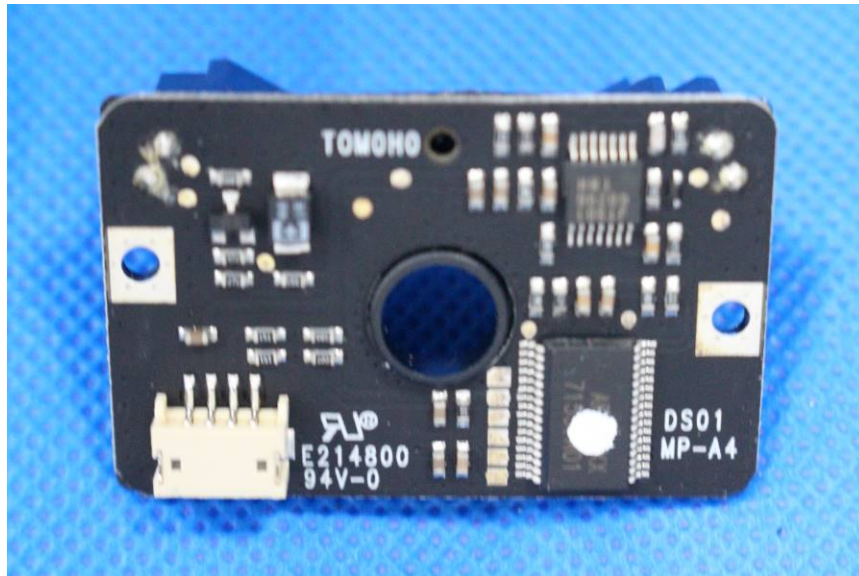

Unless otherwise agreed in writing, this document is issued by the Company subject to its General Conditions of Service printed overleaf, available on request or accessible at <http://www.sgs.com/en/Terms-and-Conditions.aspx> and, for electronic format documents, subject to Terms and Conditions for Electronic Documents at <http://www.sgs.com/en/Terms-and-Conditions/Terms-e-Document.aspx>. Attention is drawn to the limitation of liability, indemnification and jurisdiction issues defined therein. Any holder of this document is advised that information contained hereon reflects the Company's findings at the time of its intervention only and within the limits of Client's instructions, if any. The Company's sole responsibility is to its Client and this document does not exonerate parties to a transaction from exercising all their rights and obligations under the transaction documents. This document cannot be reproduced except in full, without prior written approval of the Company. Any unauthorized alteration, forgery or falsification of the content or appearance of this document is unlawful and offenders may be prosecuted to the fullest extent of the law. Unless otherwise stated the results shown in this test report refer only to the sample(s) tested and such sample(s) are retained for 30 days only.

Attention: To check the authenticity of testing /inspection report & certificate, please contact us at telephone: (86-755) 8307 1443, or email: CN.Doccheck@sgs.com

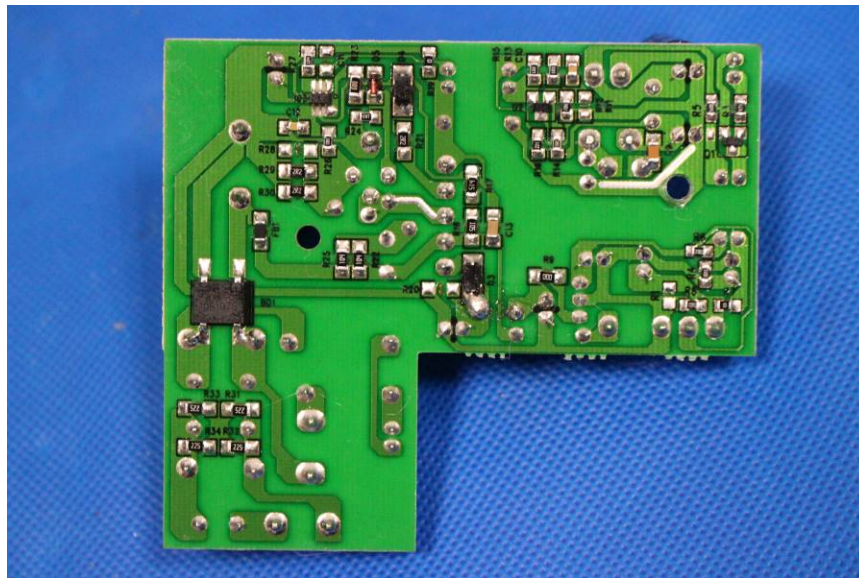
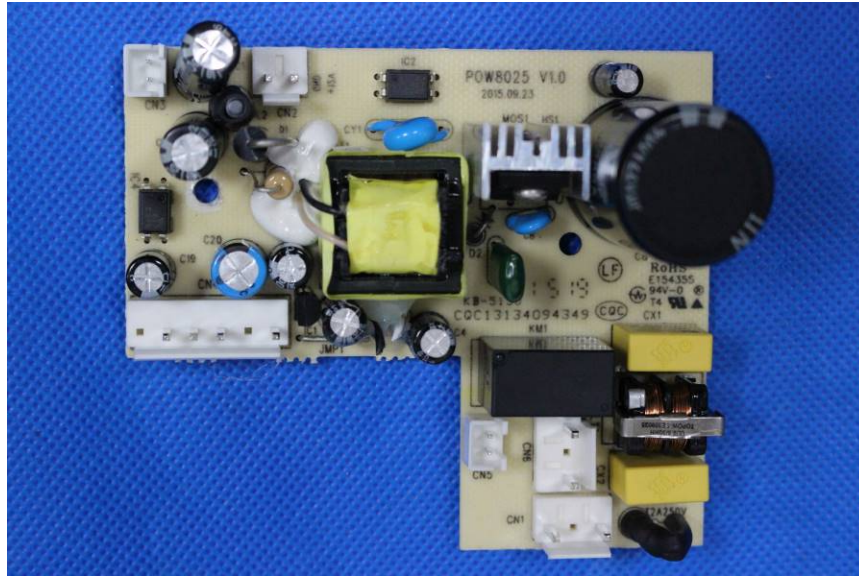

Unless otherwise agreed in writing, this document is issued by the Company subject to its General Conditions of Service printed overleaf, available on request or accessible at <http://www.sgs.com/en/Terms-and-Conditions.aspx> and, for electronic format documents, subject to Terms and Conditions for Electronic Documents at <http://www.sgs.com/en/Terms-and-Conditions/Terms-e-Document.aspx>. Attention is drawn to the limitation of liability, indemnification and jurisdiction issues defined therein. Any holder of this document is advised that information contained hereon reflects the Company's findings at the time of its intervention only and within the limits of Client's instructions, if any. The Company's sole responsibility is to its Client and this document does not exonerate parties to a transaction from exercising all their rights and obligations under the transaction documents. This document cannot be reproduced except in full, without prior written approval of the Company. Any unauthorized alteration, forgery or falsification of the content or appearance of this document is unlawful and offenders may be prosecuted to the fullest extent of the law. Unless otherwise stated the results shown in this test report refer only to the sample(s) tested and such sample(s) are retained for 30 days only.

Attention: To check the authenticity of testing /inspection report & certificate, please contact us at telephone: (86-755) 8307 1443, or email: CN.Doccheck@sgs.com

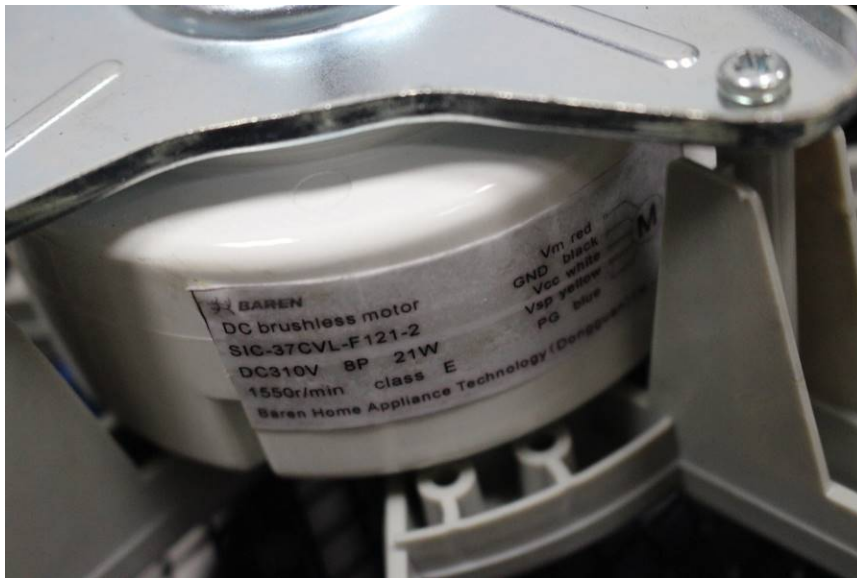
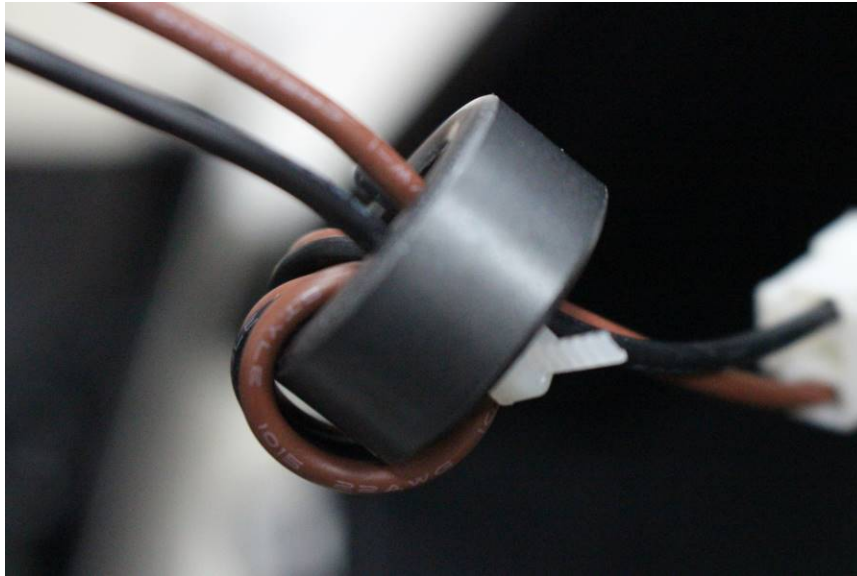

Unless otherwise agreed in writing, this document is issued by the Company subject to its General Conditions of Service printed overleaf, available on request or accessible at <http://www.sgs.com/en/Terms-and-Conditions.aspx> and, for electronic format documents, subject to Terms and Conditions for Electronic Documents at <http://www.sgs.com/en/Terms-and-Conditions/Terms-e-Document.aspx>. Attention is drawn to the limitation of liability, indemnification and jurisdiction issues defined therein. Any holder of this document is advised that information contained hereon reflects the Company's findings at the time of its intervention only and within the limits of Client's instructions, if any. The Company's sole responsibility is to its Client and this document does not exonerate parties to a transaction from exercising all their rights and obligations under the transaction documents. This document cannot be reproduced except in full, without prior written approval of the Company. Any unauthorized alteration, forgery or falsification of the content or appearance of this document is unlawful and offenders may be prosecuted to the fullest extent of the law. Unless otherwise stated the results shown in this test report refer only to the sample(s) tested and such sample(s) are retained for 30 days only.

Attention: To check the authenticity of testing /inspection report & certificate, please contact us at telephone: (86-755) 8307 1443, or email: CN.Doccheck@sgs.com

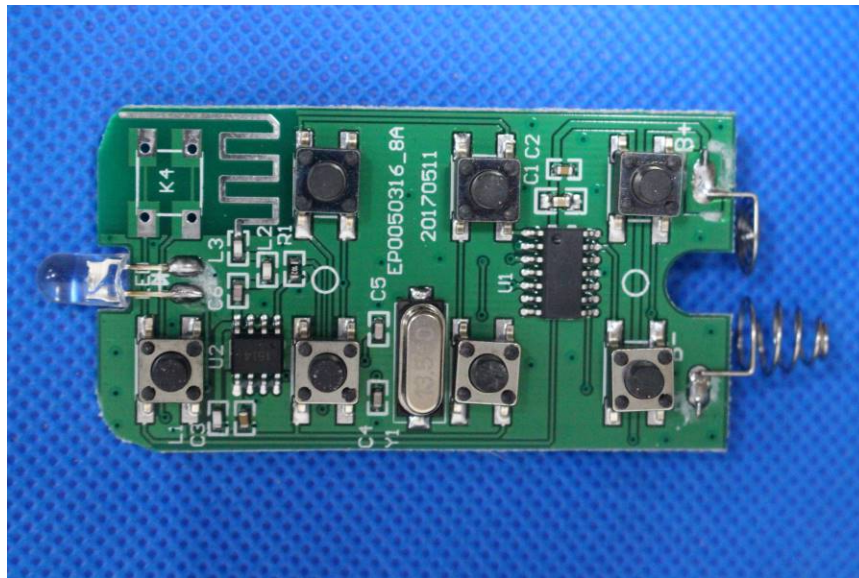

Unless otherwise agreed in writing, this document is issued by the Company subject to its General Conditions of Service printed overleaf, available on request or accessible at <http://www.sgs.com/en/Terms-and-Conditions.aspx> and, for electronic format documents, subject to Terms and Conditions for Electronic Documents at <http://www.sgs.com/en/Terms-and-Conditions/Terms-e-Document.aspx>. Attention is drawn to the limitation of liability, indemnification and jurisdiction issues defined therein. Any holder of this document is advised that information contained hereon reflects the Company's findings at the time of its intervention only and within the limits of Client's instructions, if any. The Company's sole responsibility is to its Client and this document does not exonerate parties to a transaction from exercising all their rights and obligations under the transaction documents. This document cannot be reproduced except in full, without prior written approval of the Company. Any unauthorized alteration, forgery or falsification of the content or appearance of this document is unlawful and offenders may be prosecuted to the fullest extent of the law. Unless otherwise stated the results shown in this test report refer only to the sample(s) tested and such sample(s) are retained for 30 days only.

Attention: To check the authenticity of testing / inspection report & certificate, please contact us at telephone: (86-755) 8307 1443, or email: CN.Doccheck@sgs.com

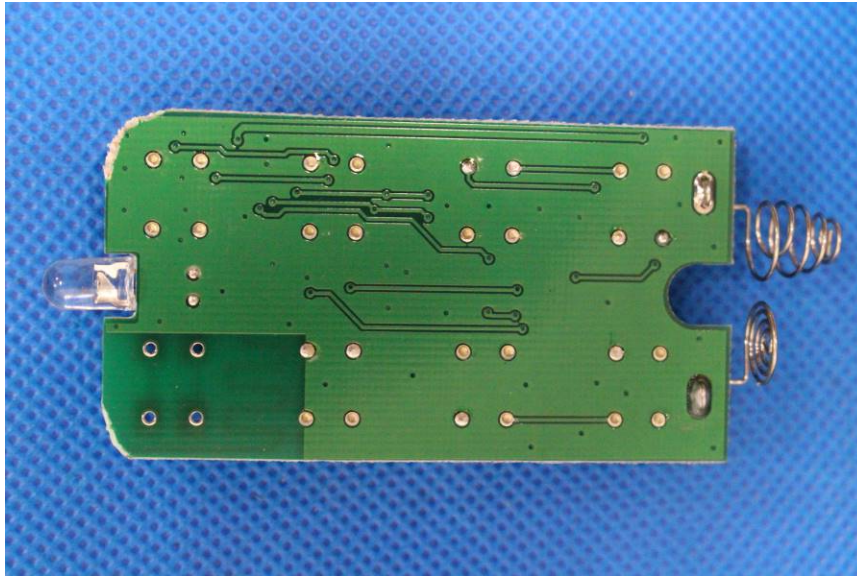

--End of Report--



Unless otherwise agreed in writing, this document is issued by the Company subject to its General Conditions of Service printed overleaf, available on request or accessible at <http://www.sgs.com/en/Terms-and-Conditions.aspx> and, for electronic format documents, subject to Terms and Conditions for Electronic Documents at <http://www.sgs.com/en/Terms-and-Conditions/Terms-e-Document.aspx>. Attention is drawn to the limitation of liability, indemnification and jurisdiction issues defined therein. Any holder of this document is advised that information contained hereon reflects the Company's findings at the time of its intervention only and within the limits of Client's instructions, if any. The Company's sole responsibility is to its Client and this document does not exonerate parties to a transaction from exercising all their rights and obligations under the transaction documents. This document cannot be reproduced except in full, without prior written approval of the Company. Any unauthorized alteration, forgery or falsification of the content or appearance of this document is unlawful and offenders may be prosecuted to the fullest extent of the law. Unless otherwise stated the results shown in this test report refer only to the sample(s) tested and such sample(s) are retained for 30 days only.

Attention: To check the authenticity of testing /inspection report & certificate, please contact us at telephone: (86-755) 8307 1443, or email: CN.Doccheck@sgs.com